

Harmonic Identification for Active Power Filters Via Adaptive Tabu Search Method

Thanatchai Kulworawanichpong, Kongpol Areerak,
Kongpan Areerak, and Sarawut Sujitjorn

School of Electrical Engineering, Suranaree University of Technology
Nakhon Ratchasima, 30000, Thailand
sarawut@ccs.sut.ac.th

Abstract. Harmonic identification by using Adaptive Tabu Search (ATS) Method embedded in the active power filter is proposed in this paper. The use of the ATS identifies harmonic components more accurately and precisely. Besides the accuracy and precision, it is able to select only some particular harmonic orders that cause severe consequences to the system for elimination. This principle thus leads to the reduction in size and cost of hardware implementation + active power filters. In this paper, two test current waveforms are simulated to validate and verify the performance of the proposed algorithm. The satisfactory results obtained by this identification method are also compared against those obtained by the d-q axis based harmonic identification method. As a result, the ATS based method has better performance for eliminating only selective harmonic orders over the d-q method. Furthermore, the compensated current from the proposed method has a good transient response while there is the first-cycle delay due to the use of the d-q method.

1 Introduction

To date, power electronic converters have been successfully developed and widely used in various industrial applications. Their principle is based on the high-speed operation of power switching devices in such a way that their waveforms are characterized in order to control power transfer between the two sides of the converters. It is the fact that the use of such high-speed devices operating at higher frequency than the fundamental inevitably causes undesired harmonic components. These components are troublesome to power supplies especially ones with highly sensitive electronic loads. Harmonic as “pollution” in electrical networks may cause unpredictable events to harm electric appliances such as cogging and crawling in motors [1], reduction in accuracy and precision of protective devices which could damage a power system or even harm the system operators [2, 3].

In general, harmonic power filters can be categorized into passive and active classes. For passive filters, they are limited to fixed orders for compensation. A design must set up the filter to compensate some selected harmonic components only, while the others

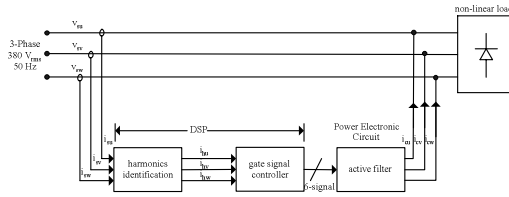

Fig. 1. Block diagram of an active power filter

are still there. Unlike passive ones, active power filters [4] are more efficient due to the ability of their switching devices to generate adjustable compensating current. Most active power filters have their structures similar to that shown in figure 1. The operation of the active power filter requires harmonic identification via so-called “harmonic identifier”. This identifier must have an ability to detect most harmful harmonics in an unhealthy power supply for elimination. Thus, this paper is focused on study and comparison of two harmonic identification methods: 1) d-q axis (DQ) [5] harmonic identification method and Adaptive Tabu search (ATS) [6] harmonic identification method. To assess the effectiveness of each identification, their principles are briefly reviewed, method-by-method, in Section 2 while two test waveforms and results are situated in Section 3.

2 Algorithms for Harmonic Identification

2.1 d-q Axis Harmonic Identification Method

This identification is based on the concept of transforming three-phase current (u, v and w phases) to two-phase current (α and β phases), which can be written in a compact matrix as in equation (1).

$$\begin{bmatrix} i_\alpha \\ i_\beta \end{bmatrix} = \sqrt{\frac{2}{3}} \begin{bmatrix} 1 & -\frac{1}{2} & -\frac{1}{2} \\ 0 & \frac{\sqrt{3}}{2} & -\frac{\sqrt{3}}{2} \end{bmatrix} \begin{bmatrix} i_u \\ i_v \\ i_w \end{bmatrix} \tag{1}$$

From the two-phase model, the current is then transformed again but this time to the rotated d-q axis rotating with the speed of a selected harmonic frequency as described by equation (2).

$$\begin{bmatrix} i_d \\ i_q \end{bmatrix} = \begin{bmatrix} \cos(\omega t) & \sin(\omega t) \\ -\sin(\omega t) & \cos(\omega t) \end{bmatrix} \begin{bmatrix} i_\alpha \\ i_\beta \end{bmatrix} \tag{2}$$

When the selected harmonic to be eliminated is transferred to the d-q axis, it appears to be stand still, this harmonic is simply sifted by using a low-pass filter. Let i_{dh} and i_{qh} are the h^{th} harmonic components on the d-q axis, $i_{\alpha h}$ and $i_{\beta h}$ are the corresponding components transferred to the $\alpha\beta$ axis, and i_{uh} , i_{vh} and i_{wh} are the selected harmonic components to be eliminated that are transferred back to the three-phase system. Moreover, the DQ detection method can be schematically summarized in figure 2.

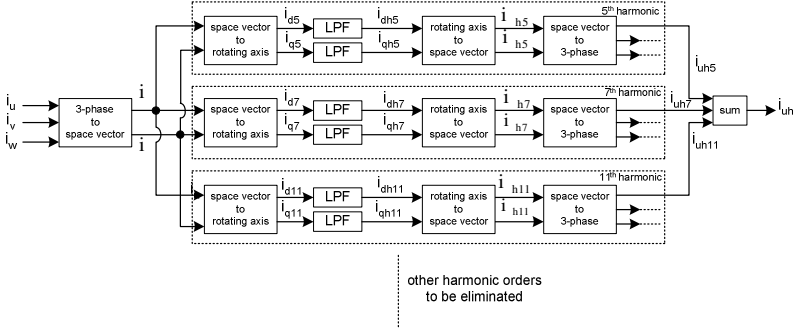

Fig. 2. Block diagram for the DQ harmonic detection method

2.2 Adaptive Tabu Search Harmonic Detection Method

Adaptive Tabu Search (ATS) Method [6] is a modified form of the original Tabu search proposed by Glover [7] in 1986 especially for combinatorial optimization problems. The modified version was developed according to the need for a powerful search method to solve non-linear continuous optimization problems. The essence of this method, which distinguishes itself from the original is that 1) a continuous search space must be discretized and 2) back-tracking and adaptive radius features are employed to enhance the overall performance of the search process [6]. Its effectiveness has been proved and verified by some intensive works [6,8]. In this paper, the ATS method is selected to be an alternative for the application of active power filters. It is used to identify harmonic contents of a one-period-sampled non-sinusoidal waveform as described by the flow diagram in figure 3. The proposed algorithm begins with examining harmonic components, order-by-order, against the IEEE519-1992 standard [9]. Thus, only orders that do not pass the standard are compensated for. This leads to the less compensation from the harmonic power filter.

Given that equation (3) describes a harmonic current waveform.

$$\hat{i}(t) = \sum_{h=1}^{\infty} I_h \sin(h\omega t + \phi_h) \tag{3}$$

where I_h and ϕ_h are the magnitude and phase of the h^{th} harmonic order respectively, while ω is the fundamental frequency in rad/s. With the ATS method applied to this scheme, I_h and ϕ_h of not-passed orders are adjusted in order to minimize the objective

function written in equations (4) and (5). The proposed method is initialized by using the harmonic components obtained from the FFT to speed up the process. At the end, an obtained solution that best fits the objective is used to command the active power filter.

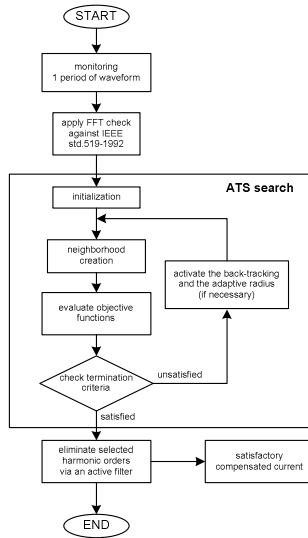

Fig. 3. Harmonics identification via ATS

$$J = \sum e^2(kT); kT = 0,1,2,\dots \tag{4}$$

$$\cos t \text{ function} = \min(J) \tag{5}$$

3 Results and Discussions

The two harmonic detection algorithms reviewed in the previous section are challenged by two waveforms as shown in figures 4 and 7 to situate the tests. The results obtained from each method are compared to evaluate their compensation performance. The comparison is illustrated, case-by-case, as follows.

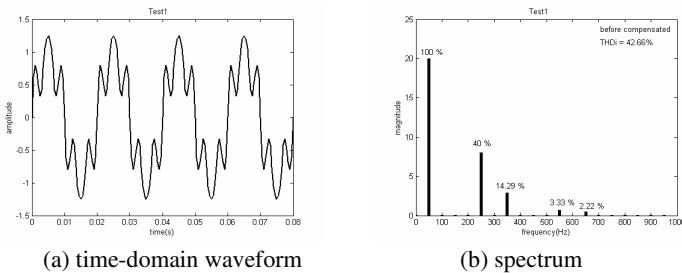

Fig. 4. Test current for Test Case 1

3.1 Test Case 1

Table 1 presents the error on the harmonic identification performed by each method in comparison with the actual one. It reveals that the error from the ATS method is less than that from the DQ method. Note that the 11th and the 13th harmonic orders are not taken into account because they satisfy the standard.

Table 1. Case-1 comparison between the harmonic components detected by the two methods

| Order | Actual (magnitude) | DQ | | ATS | |
|-----------|--------------------|--------------|--------------|--------------|--------------|
| | | magnitude | error | magnitude | error |
| 5 | 8.00 (40%) | 8.089 | 1.11% | 8.00 | 0.03% |
| 7 | 2.86 (14.3%) | 2.88 | 0.70% | 2.86 | 0.05% |
| 11 | 0.67 (3.33%) | satisfy std. | satisfy std. | satisfy std. | satisfy std. |
| 13 | 0.44 (2.22%) | satisfy std. | satisfy std. | satisfy std. | satisfy std. |
| rms error | | | 0.93% | | 0.04% |

When the compensating current from the active power filter based on each method is injected to the system, the source current is therefore shaped to be a purely sinusoidal waveform as shown in figures 5 and 6 for the DQ and ATS methods, respectively.

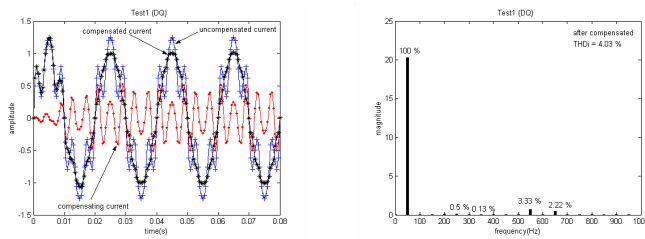

Fig. 5. Corresponding waveforms and spectrum due to the DQ harmonic detection for Test Case 1

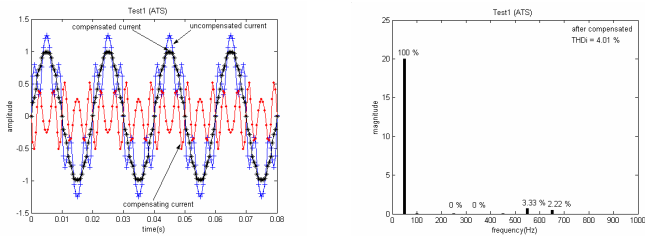

Fig. 6. Corresponding waveforms and spectrum due to the ATS harmonic detection for Test Case 1

Clearly, figure 5 shows that the DQ method for harmonic detection has the delay (failure to perform the compensation) within the first cycle of the operation. This delay is because the appearance of the poles in the LPF. In contrast, there is no delay when the ATS harmonic detection is used. In addition, as a result, the ATS detection method has better ability to compensate the fifth and seventh harmonic orders of the test waveform. Nevertheless, the results obtained from both methods satisfy the IEEE standard.

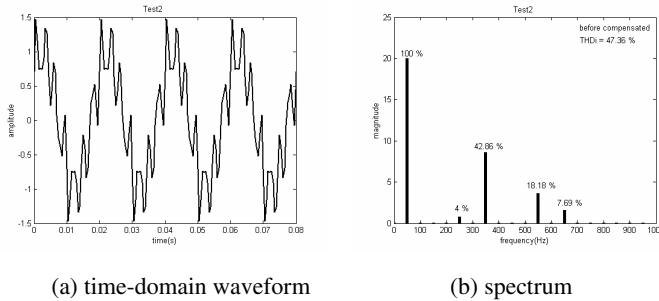

Fig. 7. Test current for Test Case 2

Table 2. Case-2 comparison between the harmonic components detected by the two methods

| Order | Actual (magnitude) | DQ | | ATS | |
|-----------|--------------------|--------------|--------------|--------------|--------------|
| | | magnitude | error | magnitude | error |
| 5 | 0.80 (4%) | satisfy std. | satisfy std. | satisfy std. | satisfy std. |
| 7 | 8.57 (42.85%) | 8.61 | 0.47% | 8.57 | 0.01% |
| 11 | 3.64 (18.2%) | 3.67 | 0.83% | 3.64 | 0.03% |
| 13 | 1.54 (7.7%) | 1.55 | 0.65% | 1.54 | 0.07% |
| rms error | | 0.67% | | 0.04% | |

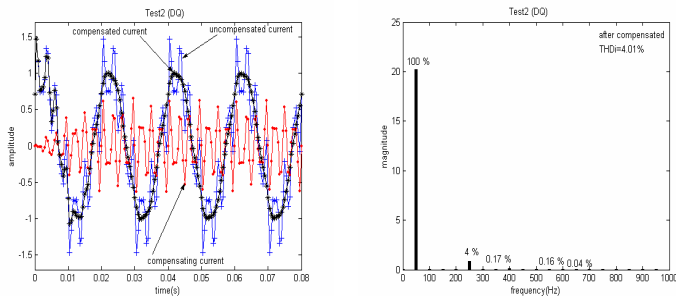

Fig. 8. Corresponding waveforms and spectrum due to the DQ harmonic detection for Test Case 2

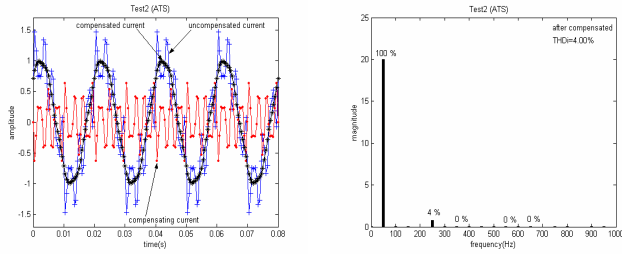

Fig. 9. Corresponding waveforms and spectrum due to the ATS harmonic detection for Test Case 2

3.2 Test Case 2

In this test case, only the fifth-order harmonic passes the standard and is not needed to be identified. The results of this test give the similar conclusion to the previous test case. The ATS detection method is noticeably better in the harmonic detection in such a way that a compensating current from the active power filter is able to suppress any chosen harmonic orders completely, and also the transient response of the compensated current as shown in figures 8 and 9. Note again that the results obtained from both methods satisfy the standard.

4 Conclusions

This work proposes a new harmonic detection algorithm based on the ATS method. It gives less errors than the DQ method does when comparing the compensated current to the fundamental. In addition, it has the special feature to select some orders of the harmonic waveform to be eliminated. This may lead to the reduction of cost and size of the active power filter. Furthermore, the proposed method is better in transient responses. Although the DQ detection algorithm is not as good as the ATS method in this consideration, it still passes the IEEE 519-1992 standard as its THDi and spectrum.

Acknowledgement

The financial support from Suranaree University of Technology is greatly acknowledged.

References

1. IEEE Standard 141-1993: Harmonics in Power Systems.
2. Brozek, J.P.: The Effects of Harmonics on Overcurrent Protection Devices, IEEE Industry Applications Society Conference, 2 (1990) 1965-1967

3. Ho, J.M. and Liu, C.C.: The Effects of Harmonics on Differential Relay for a Transformer, IEE International Conference and Exhibition on Electricity Distribution (CIRED), 2 (2001)
4. Jung, G.H. and Cho, G.H.: New Active Power Filter with Simple Low Cost Structure without Tuned Filters, IEEE Power Electronics Specialists Conference (PESC'98), 1 (1998) 217-222
5. Takeda, M., Ikeda, K., Teramoto, A. and Aritsuka, T.: Harmonic Current and Reactive Power Compensation with an Active Filter, IEEE Power Electronics Specialists Conference (PESC '88), 2 (1988) 1174-1179
6. Puangdownreong, D., Areerak, K-N., Srikaew, A., Sujitjorn, S. and Totarong, P.: System Identification via Adaptive Tabu Search, IEEE Int. Conf. on Industrial Technology (ICIT'02), 2 (2002) 915-920
7. Glover, F.: Future paths for integer programming and links to artificial intelligence. Computers and Operations Research 13 (1986) 553-549
8. Kulworawanichpong, T., Puangdownreong, D. and Sujitjorn, S.: Finite Convergence of Adaptive Tabu Search, ASEAN. Journal (accepted).
9. IEEE Standard 519-1992.