

การปลูกและการกำหนดลักษณะเฉพาะของผลึกบริสุทธิ์และที่ถูกล้าง  
เจือของซิงค์ไทโอยูเรียคลอไรด์ โพลแทสเซียมไดไฮโดรเจนฟอสเฟตและ  
แอมโมเนียมไดไฮโดรเจนฟอสเฟต

นายนครินทร์ พัฒนบุญมี

วิทยานิพนธ์นี้เป็นส่วนหนึ่งของการศึกษาตามหลักสูตรปริญญาวิทยาศาสตรดุษฎีบัณฑิต  
สาขาวิชาฟิสิกส์  
มหาวิทยาลัยเทคโนโลยีสุรนารี  
ปีการศึกษา 2552

**GROWTH AND CHARACTERIZATION OF  
PURE AND DOPED SINGLE CRYSTALS OF  
ZINC THIOUREA CHLORIDE, POTASSIUM  
DIHYDROGEN PHOSPHATE AND  
AMMONIUM DIHYDROGEN PHOSPHATE**

**Nakarin Pattanaboonmee**

**A Thesis Submitted in Partial Fulfillment of the Requirements for the**

**Degree of Doctor of Philosophy in Physics**

**Suranaree University of Technology**

**Academic Year 2009**

# GROWTH AND CHARACTERIZATION OF

Suranaree University of Technology has approved this thesis submitted in partial fulfillment of the requirements for the Degree of Doctor of Philosophy.

Thesis Examining Committee

---

(Asst. Prof. Dr. Chinorat Kobdaj)

Chairperson

---

(Assoc. Prof. Dr. Prapun Manyum)

Member (Thesis Advisor)

---

(Prof. Dr. P. Ramasamy)

Member (Thesis Co-Advisor)

---

(Prof. Dr. Pichet Limsuwan)

Member

---

(Dr. Saroj Rujirawat)

Member

---

(Prof. Dr. Sukit Limpijumnong)

Vice Rector for Academic Affairs

---

(Assoc. Prof. Dr. Prapun Manyum)

Dean of Institute of Science

นครินทร์ พัฒนบุญมี : การปลูกและการกำหนดลักษณะเฉพาะของผลึกบริสุทธิ์และที่ถูกร  
เจือของซิงค์ไทโอยูเรียคลอไรด์ โพลแทสเซียมไดไฮโดรเจนฟอสเฟตและแอมโมเนียม  
ไดไฮโดรเจนฟอสเฟต (GROWTH AND CHARACTERIZATION OF PURE  
AND DOPED SINGLE CRYSTALS OF ZINC THIOUREA CHLORIDE,  
POTASSIUM DIHYDROGEN PHOSPHATE AND AMMONIUM  
DIHYDROGEN PHOSPHATE) อาจารย์ที่ปรึกษา : รองศาสตราจารย์ ดร.ประพันธ์  
แมนย่า, 90 หน้า.

วิทยานิพนธ์นี้เกี่ยวข้องกับการปลูกและการกำหนดลักษณะเฉพาะของผลึกเดี่ยวซิงค์ไทโอ  
ยูเรียคลอไรด์ ผลึกเดี่ยวโพแทสเซียมไดไฮโดรเจนฟอสเฟตและแอมโมเนียมไดไฮโดรเจนฟอสเฟต  
ซึ่งถูกเจือด้วยกรดอะมิโนที่ทำการปลูกทั้งโดยวิธีดั้งเดิมและวิธีเอสอาร์ โครงสร้างผลึกและหมู่  
ฟังก์ชันของผลึกที่ปลูกขึ้น ได้รับการยืนยันจากการศึกษาการเลี้ยวเบนของรังสีเอกซ์และการศึกษา  
ฟูเรียร์ทรานส์ฟอร์มอินฟราเรด จากการวิเคราะห์การดูดกลืนแสงพบว่า ผลึกซิงค์ไทโอยูเรียคลอไรด์  
บริสุทธิ์และที่ถูกรเจือด้วยโพแทสเซียมไดไฮโดรเจนฟอสเฟตในปริมาณ 0.2 โมลเปอร์เซ็นต์ ผลึกแอมโมเนียมได  
ไฮโดรเจนฟอสเฟตและโพแทสเซียมไดไฮโดรเจนฟอสเฟตที่ถูกรเจือมีค่าการดูดกลืนแสงต่ำในช่วง  
ความยาวคลื่นแสงที่ตามองเห็นซึ่งเป็นสมบัติจำเป็นต่อการนำไปประยุกต์ใช้ทางด้านทัศนศาสตร์ไม่  
เชิงเส้น ผลการวัดค่าไดอิเล็กทริกและวัดความแข็งระดับจุลภาค แสดงให้เห็นว่าผลึกซึ่งปลูกโดยวิธี  
เอสอาร์มีความสมบูรณ์ของผลึกสูงและมีความหนาแน่นของความบกพร่องต่ำ การมีสมบัติทาง  
ไดอิเล็กทริกที่ดีแสดงให้เห็นว่า ผลึกเดี่ยวของซิงค์ไทโอยูเรียคลอไรด์ ผลึกแอมโมเนียมได  
ไฮโดรเจนฟอสเฟตและโพแทสเซียมไดไฮโดรเจนฟอสเฟตที่ถูกรเจือซึ่งปลูกโดยวิธีเอสอาร์อาจมี  
ประโยชน์มากในการประยุกต์ใช้ทางด้านทัศนศาสตร์ไม่เชิงเส้น

สาขาวิชาฟิสิกส์  
ปีการศึกษา 2552

ลายมือชื่อนักศึกษา \_\_\_\_\_  
ลายมือชื่ออาจารย์ที่ปรึกษา \_\_\_\_\_  
ลายมือชื่ออาจารย์ที่ปรึกษาร่วม \_\_\_\_\_

NAKARIN PATTANABOONMEE : GROWTH AND  
CHARACTERIZATION OF PURE AND DOPED SINGLE CRYSTALS  
OF ZINC THIOUREA CHLORIDE, POTASSIUM DIHYDROGEN  
PHOSPHATE AND AMMONIUM DIHYDROGEN PHOSPHATE.  
THESIS ADVISOR: ASSOC. PROF. PRAPUN MANYUM, D.Phil.  
90 PP.

This thesis is concerned with the growth and characterization of single crystals of zinc thiourea chloride, amino acid doped potassium dihydrogen phosphate and doped ammonium dihydrogen phosphate by both conventional and SR methods. The crystal structure and functional groups were confirmed by powder X-ray diffraction and FTIR studies. The optical absorption analysis revealed that the pure zinc thiourea chloride, 0.2 mole % of  $K^+$  doped zinc thiourea chloride, doped ammonium dihydrogen phosphate and doped potassium dihydrogen phosphate crystals have very low percentage of absorption in the entire visible region which is very essential for nonlinear optical applications. Dielectric and microhardness measurements indicate that the crystals grown by the SR method have good crystalline perfection and low density of defects. The good dielectric properties show that the zinc thiourea chloride, doped ammonium dihydrogen phosphate and doped potassium dihydrogen phosphate single crystals grown by the SR method may be very useful for variety of nonlinear optical applications.

School of Physics

Academic Year 2009

Student's Signature \_\_\_\_\_

Advisor's Signature \_\_\_\_\_

Co-Advisor's Signature \_\_\_\_\_

## ACKNOWLEDGEMENTS

The author, Mr. Nakarin Pattanaboonmee would like to thank University Staff Development Scholarships from KMUTT for financial support for Ph.D. scholarship and thank Centre of Crystal Growth, SSN college of Engineering, India for very useful discussions and also thank Assoc. Prof. Dr. Prapun Manyum and Prof. Dr. P. Ramasamy, my thesis advisors. Thanks for very useful suggestions from Asst. Prof. Dr. Chinorat Kobdaj, Prof. Dr. Pichet Limsuwan and Dr. Saroj Rujirawat, thesis examining committee. Help received from Dr. Jakrapong Kaewkhao (Nakhon Pathom Rajabhat University) for the UV-Visible spectroscopic studies, Dr. Rattikorn Yimmirun for dielectric study and National Metal and Materials Technology Center (MTEC) for mechanical and thermal properties study is acknowledged.

Nakarin Pattanaboonmee

# CONTENTS

	Page
ABSTRACT IN THAI . . . . .	I
ABSTRACT IN ENGLISH . . . . .	II
ACKNOWLEDGEMENTS . . . . .	III
CONTENTS . . . . .	IV
LIST OF FIGURES . . . . .	IX
LIST OF ABBREVIATIONS . . . . .	XIV
<b>CHAPTER</b>	
<b>I INTRODUCTION . . . . .</b>	<b>1</b>
1.1 Rationale of the study . . . . .	1
1.2 Research objective . . . . .	3
1.3 Scope and limitation of the study . . . . .	4
1.4 References . . . . .	4
<b>II REVIEW OF THE LITERATURE . . . . .</b>	<b>6</b>
2.1 Nonlinear optical materials . . . . .	6
2.2 Thiourea and metal-organic materials . . . . .	10
2.3 Metal complexes of thiourea . . . . .	11
2.4 Amino acid doped KDP crystals . . . . .	13
2.5 Amino acid doped ADP crystals . . . . .	15
2.6 Conventional and Sankaranarayanan-Ramasamy solution growth methods . . . . .	16
2.7 References . . . . .	19

## CONTENTS (Continued)

	Page
<b>III GROWTH AND CHARACTERIZATION OF THE PURE AND K<sup>+</sup> DOPED ZINC THIOUREA CHLORIDE CRYSTALS</b>	24
3.1 Abstract . . . . .	24
3.2 Introduction . . . . .	24
3.3 Experimental . . . . .	26
3.3.1 Material preparation . . . . .	26
3.3.2 Crystal growth by the conventional slow evaporation technique	26
3.3.3 Crystal growth of the pure ZTC by the SR method . . . . .	26
3.4 Characterization . . . . .	27
3.4.1 X-ray diffraction analysis . . . . .	27
3.4.2 FTIR studies . . . . .	29
3.4.3 Optical property studies . . . . .	29
3.4.4 Dielectric constant . . . . .	30
3.5 Conclusion . . . . .	31
3.6 References . . . . .	33
<b>IV GROWTH AND CHARACTERIZATION OF PURE, L-ARGININE AND GLYCINE DOPED ADP CRYSTALS</b>	35
4.1 Abstract . . . . .	35
4.2 Introduction . . . . .	35
4.3 Crystal growth procedure . . . . .	37
4.3.1 Metastable zone studies . . . . .	37
4.3.2 Crystal growth by the conventional slow evaporation technique	37
4.3.3 Crystal growth of the pure and doped ADP by the SR method	38



## CONTENTS (Continued)

	<b>Page</b>
4.4 Characterization . . . . .	40
4.4.1 Thermal properties . . . . .	40
4.4.2 X-ray diffraction analysis . . . . .	41
4.4.3 FTIR studies . . . . .	43
4.4.4 Optical property studies . . . . .	44
4.4.5 Dielectric properties . . . . .	46
4.4.6 Microhardness testing . . . . .	49
4.5 Conclusion . . . . .	51
4.6 References . . . . .	52
<b>V GROWTH AND CHARACTERIZATION OF GLYCINE DOPED KDP SINGLE CRYSTALS . . . . .</b>	<b>54</b>
5.1 Abstract . . . . .	54
5.2 Introduction . . . . .	54
5.3 Experimental . . . . .	56
5.3.1 Crystal growth . . . . .	56
5.3.2 Characterization . . . . .	57
5.4 Results and discussions . . . . .	58
5.4.1 X-ray diffraction analysis . . . . .	58
5.4.2 FTIR studies . . . . .	59
5.4.3 Optical property studies . . . . .	60
5.4.4 Dielectric constant . . . . .	61
5.4.5 Microhardness testing . . . . .	64
5.4.6 Thermal studies . . . . .	64

## CONTENTS (Continued)

	<b>Page</b>
5.5 Conclusion . . . . .	65
5.6 References . . . . .	66
<b>VI GROWTH AND CHARACTERIZATION OF L-ARGININE</b>	
<b>DOPED KDP SINGLE CRYSTALS . . . . .</b>	<b>69</b>
6.1 Abstract . . . . .	69
6.2 Introduction . . . . .	69
6.3 Experimental . . . . .	70
6.3.1 Crystal growth by the conventional slow evaporation technique	70
6.3.2 Crystal growth of the doped KDP by the SR method . . . . .	71
6.4 Characterization . . . . .	72
6.4.1 X-ray diffraction analysis . . . . .	72
6.4.2 FTIR studies . . . . .	74
6.4.3 Optical property studies . . . . .	75
6.4.4 Dielectric constant . . . . .	76
6.4.5 Microhardness testing . . . . .	77
6.4.6 Thermal studies . . . . .	80
6.5 Conclusion . . . . .	81
6.6 References . . . . .	82
<b>VII CONCLUSIONS . . . . .</b>	<b>85</b>
7.1 Growth and characterization of the pure and K <sup>+</sup> doped zinc thiourea chloride crystals . . . . .	85
7.2 Growth and characterization of the pure, L-arginine and glycine doped ADP single crystals . . . . .	86

## CONTENTS (Continued)

	<b>Page</b>
7.3 Growth of the amino acid glycine doped KDP single crystals and their characterization . . . . .	87
7.4 Growth of the amino acid L-arginine doped KDP single crystals and their characterization . . . . .	88
CURRICULUM VITAE . . . . .	90

## LIST OF FIGURES

Figure		Page
2.1	Energy-level diagram describing second-harmonic generation. . . .	8
2.2	Structure of thiourea (Stewart, 1957). . . . .	10
2.3	Morphology of ZTC crystals grown at pH 4.5 (Rajasekaran et al., 2001). . . . .	12
2.4	Solubility curve for ZTC at different temperatures (Rajasekaran et al., 2001). . . . .	13
2.5	FTIR spectrum of ZTC (Rajasekaran et al., 2001). . . . .	13
2.6	Solubility Diagram (Santharaghavan and Ramasamy, 2000). . . .	17
2.7	Schematic diagram of the experimental set-up (Sankaranarayanan and Ramansamy, 2005). . . . .	18
3.1	The pure ZTC seed crystal grown in 1 week. . . . .	27
3.2	SR method experimental set-up. . . . .	28
3.3	The pure ZTC crystal grown by the SR method. . . . .	28
3.4	X-ray powder diffractogram of the pure ZTC crystals grown by both conventional (a) and SR (b) methods. . . . .	29
3.5	The FTIR spectrum of the pure ZTC crystals grown by the con- ventional method. . . . .	30
3.6	UV-visible spectra of the pure and $K^+$ doped ZTC grown by the conventional method. . . . .	30
3.7	Dielectric constant of the pure and $K^+$ doped ZTC crystals grown by the conventional method. . . . .	32

## LIST OF FIGURES (Continued)

Figure	Page
3.8	Dielectric constant of the pure ZTC grown by conventional method and SR method. . . . . 32
3.9	Dielectric loss ( $\epsilon''$ ) of the pure ZTC crystals grown by conventional and SR techniques. . . . . 33
4.1	Solubility curve (a), Metastability limit of pure ADP (b), 1 mole % glycine doped ADP (c) and 1 mole % L-arginine doped ADP(d). 38
4.2	ADP crystals grown from aqueous solutions containing different concentrations of L-arginine : (a) 0 mole %, (b) 1 mole %, (c) 2 mole %, (d) 3 mole %, and different concentrations of glycine: (e) 1 mole %, (f) 2 mole %, (g) 3 mole %. . . . . 39
4.3	The 1 mole % L-arginine doped ADP crystal grown by SR method. 40
4.4	Differential Scanning Calorimetry (DSC) data of the pure ADP, 1 mole % glycine and 1 mole % L-arginine doped ADP crystals grown by the SR method. . . . . 41
4.5	Thermogravimetric Analysis (TGA) data of the pure ADP, 1 mole % glycine and 1 mole % L-arginine doped ADP crystals grown by the SR method. . . . . 42
4.6	X-ray powder diffractogram of the pure ADP (a), 1 mole % glycine doped ADP (b) and 1 mole % L-Arginine doped ADP (c) crystals grown by the SR method. . . . . 43

## LIST OF FIGURES (Continued)

Figure	Page
4.7	FTIR spectra of the pure ADP (a) and ADP crystals doped with 3 mole % (b), 2 mole % (c) and 1 mole % (d) glycine grown by the conventional method. . . . . 44
4.8	FTIR spectra of the ADP crystals doped with 3 mole % (a), 2 mole % (b) and 1 mole % (c) L-arginine grown by the conventional method. . . . . 45
4.9	FTIR spectra of the pure ADP (a), 1 mole % L-arginine (b) and 1 mole % glycine (c) doped ADP crystals grown by the SR method. . 45
4.10	UV-visible spectrum of the pure and glycine doped ADP crystals. . 46
4.11	UV-visible spectrum of the pure and L-arginine doped ADP crystals. 47
4.12	Frequency dependence of the dielectric constant at 50°C of the pure, 1 mole % glycine doped ADP and 1 mole % L-arginine doped ADP crystals grown by the SR method. . . . . 47
4.13	Frequency dependence of the dielectric constant at 50°C of the 1 mole % glycine doped ADP (a) and 1 mole % L-arginine doped ADP crystals (b). . . . . 48
4.14	Temperature dependence of the dielectric loss at 10 kHz of 1 mole % glycine doped ADP crystals (a) and 1 mole % L-arginine doped ADP crystals (b). . . . . 50
4.15	Vickers microhardness of the 1 mole % L-arginine doped ADP crystals. . . . . 51
4.16	Vickers microhardness of the 1 mole % glycine doped ADP crystals. 51

## LIST OF FIGURES (Continued)

Figure	Page
5.1	KDP crystals grown from aqueous solutions containing different concentrations of glycine : (a) 1 mole %, (b) 2 mole % and (c) 3 mole %. . . . . 57
5.2	Crystals grown by the SR method of 1 mole % (a), 2 mole % (b) and 3 mole % (c) glycine doped KDP. . . . . 57
5.3	X-ray powder diffractogram of pure KDP (a), 1 mole % (b), 2 mole % (c) and 3 mole % (d) glycine doped KDP crystals grown by the SR method. . . . . 59
5.4	FTIR spectra of SR method grown KDP crystals doped with 1 mole % (a), 2 mole % (b) and 3 mole % (c) of glycine. . . . . 60
5.5	UV-visible spectrum of the pure and glycine doped KDP crystals grown by the SR method. . . . . 61
5.6	Frequency dependence of dielectric constant at different temperatures of the 1 mole % (a) and 3 mole % (b) glycine doped KDP crystals grown by the SR method. . . . . 62
5.7	Temperature dependence of dielectric loss at 10 kHz of the 1 mole % glycine doped KDP crystals. . . . . 63
5.8	microhardness of the 1 mole % glycine doped KDP crystals. . . . . 64
5.9	Differential Scanning Calorimetry data of the glycine doped KDP crystals grown by the SR method. . . . . 65
5.10	Thermogravimetric Analysis data of the glycine doped KDP crystals grown by the SR method. . . . . 66

## LIST OF FIGURES (Continued)

Figure	Page
6.1	KDP crystals grown from aqueous solutions containing different concentrations of L-arginine : (a) 1 mole % , (b) 2 mole % and (c) 3 mole % . . . . . 71
6.2	The crystals grown by the SR method of 1 mol % (a), 2 mole % (b) and 3 mole % (c) L-arginine doped KDP. . . . . 72
6.3	X-ray powder diffractogram of the pure KDP (a), 1 mole % (b), 2 mole % (c) and 3 mole % (d) L-Arginine doped KDP crystals grown by the SR method. . . . . 73
6.4	FTIR spectra of SR method grown KDP crystals doped with 1 mole % (a), 2 mole % (b) and 3 mole % (c) of L-arginine. . . . . 74
6.5	UV-visible spectrum of the pure and L-arginine doped KDP crystals. 75
6.6	Frequency dependence of dielectric constant at different temperatures of the 1 mole % (a) and 3 mole % (b) L-arginine doped KDP crystals grown by the SR method. . . . . 78
6.7	Temperature dependence of dielectric loss at 10 kHz of the 1 mole % L-arginine doped KDP crystals. . . . . 79
6.8	Vickers microhardness of the 1 mole % L-arginine doped KDP crystals. . . . . 79
6.9	Differential Scanning Calorimetry (DSC) data of the pure and L-arginine doped KDP crystals grown by SR method. . . . . 80
6.10	10 Thermogravimetric Analysis data of the L-arginine doped KDP single crystals grown by the SR method. . . . . 81



## LIST OF ABBREVIATIONS

$A$	Area of parallel plate capacitor
$C$	Capacitance
$c.c.$	Complex conjugate
$\chi^{(n)}$	n-th order susceptibility
$\mathbf{D}$	Electric field displacement vector
$d$	Thickness of the sample
$d_{hkl}$	d-spacing
$\mathbf{E}$	Electric field
$E$	Evaporation rate of solvent
$E_1, E_2$	Electric field components
$E_1^*, E_2^*$	Complex electric field components
$E(t)$	Electric field as a function of time
$\varepsilon'$	Dielectric constant
$\varepsilon''$	Dielectric loss
$\varepsilon_0$	Permittivity of free space ( $8.8542 \times 10^{-14} \text{Fcm}^{-1}$ )
$\varepsilon_r$	Relative permittivity
$H_v$	Vickers hardness
$\lambda$	Wavelength
$\mathbf{P}$	Polarization
$P^{(n)}$	n-th order polarization
$P(t)$	Polarization as a function of time

**LIST OF ABBREVIATIONS (Continued)**

$\theta$	Scattering angle (or Bragg angle)
R	Growth rate
r	Radius of the vessel
S	Solubility
T	Temperature (Kelvin)
t	Time
$\tan \theta$	Dielectric loss tangent
$\omega$	Angular frequency
ADP	Ammonium dihydrogen orthophosphate
AR	Analytical reagent
BTCC	Bisthiourea cadmium chloride
CTC	Copper thiourea chloride
DFG	Difference frequency generation
DSC	Differential scanning calorimetry
EPR	Electron paramagnetic resonance
FTIR	Fourier transform infrared
ILD	Interlayer dielectric
KDP	Potassium dihydrogen orthophosphate
NLO	Nonlinear optics
OR	Optically rectified
PTC	Potassium thiourea chloride

**LIST OF ABBREVIATIONS (Continued)**

SHG	Second harmonic generation
SFG	Sum frequency generation
SR	Sankaranarayanan-Ramasamy
TGA	Thermogravimetric analysis
XRD	X-ray diffraction
ZTC	Zinc thiourea chloride

# CHAPTER I

## INTRODUCTION

### 1.1 Rationale of the study

Crystal growth is an important field of materials science, which involves controlled phase transformation. The solid state materials can be classified into single crystals, polycrystalline and amorphous materials depending on the arrangement of the constituent atoms, ions or molecules. An ideal crystal is an infinite lattice of atoms arranged in patterns which repeat in all three dimensions with repeat distance but real crystals are finite and contain defects. A single crystal consists of atomic arrays that are periodic in three dimensions with equal repeated distances (lattice spacing) in a given direction. Many types of crystals find applications in lasers, optical components for communication, thermal imaging, light emitting diodes, pyroelectric detectors etc. Semiconductor, ferroelectric, piezoelectric, laser and infrared sensitive crystals are part of solid state devices in use today. New materials are always investigated and the list of applications for crystals is on the rise. Hence growth of single crystals has become inevitable for any further developments in material research.

Nonlinear optical (NLO) frequency conversion materials have a significant impact on laser technology, optical communication and optical storage technology. The ferroelectrics KDP and ADP used in electro-optical and acousto-optical devices were the first crystals applied for nonlinear frequency conversion. However some special nonlinear optical problems called for crystals with improved properties like high transparency in the UV region, higher nonlinearity, low hygro-

scopicity etc. The search for new NLO materials over the past decade has led to the discovery of many organic NLO materials with high nonlinear susceptibilities. However, their practical applications are limited by poor optical quality, lack of robustness, low laser damage threshold properties (Hou et al., 1993) and difficulties still remain in crystal growth with sufficient quality and hardness for applications, such as optical and electro-optical sampling devices.

The approach of combining the high nonlinear optical coefficients of the organic molecules with the excellent physical properties of inorganics has been found to be overwhelmingly successful in the recent past. Thiourea, which is otherwise centrosymmetric, yields excellent noncentrosymmetric materials and typifies this approach (Venkataramanan et al., 1997). Metal complex of thiourea, commonly called semi-organics, include the advantages of both organic and inorganic part of the complex. A variety of crystals of this class have been grown by several groups (Bhat and Dharmaparakah, 1998; Selvaraju et al., 2007). The growth of single crystals of potassium thiourea bromide (PTB) was accomplished by the slow evaporation solution growth method. It is seen from the optical spectrum that PTB has good optical transmission in the entire visible region, which is an essential requirement for a nonlinear crystal (Roshan et al., 2001). The growth of single crystals of zinc thiourea chloride (ZTC) was accomplished by the slow evaporation solution growth method. Transmission spectra of ZTC revealed that the crystal has an extended transparency down to UV. The hardness values of ZTC were comparable to other semi-organic crystals. The promising crystal growth characteristics and the properties of ZTC crystal prove it to be an attractive material for harmonic generation of Nd:YAG lasers (Rajasekaran et al., 2001). Potassium dihydrogen phosphate  $\text{KH}_2\text{PO}_4$  (KDP) and ammonium dihydrogen phosphate  $\text{NH}_4\text{H}_2\text{PO}_4$  (ADP), continue to be interesting materials both academically and industrially. KDP and

ADP are representatives of hydrogen bonded crystals which possess very good electro-optic and nonlinear optical properties. ADP is antiferroelectric and KDP is ferroelectric due to the difference in the number of hydrogen bonds. With the aim of improving the Second Harmonic Generation efficiency of KDP and ADP, researchers have attempted to modify KDP and ADP crystals by doping different type of impurities such as amino acids.

There are different techniques to grow bulk crystals in which melt and solution growth techniques are mostly used. The main advantages of solution growth method are convenience, simplicity and the possible avoidance of complex growth apparatus. The use of high-purity solvent and solute and low viscosity of solution can give controlled supersaturation in growth. Crystallization from the solution, in particular slow solvent evaporation technique, has been widely used to grow nonlinear optical and several other types of crystals. Oriented crystals along prerequisite direction are very important in terms of reducing loss of material and cost during nonlinear optical device fabrication. Sankaranarayanan and Ramasamy discovered the unidirectional crystal growth from solution and have successfully grown the benzophenone single crystal with different orientations (Sankaranarayanan and Ramasamy, 2005).

This thesis is concerned with the growth of pure and doped single crystals of zinc thiourea chloride, potassium dihydrogen phosphate and ammonium dihydrogen phosphate by both conventional and Sankaranarayanan -Ramasamy methods and the characterization of grown crystals.

## 1.2 Research objective

The objectives of this thesis are as follow:

1.2.1 Growth of pure and doped ZTC crystals which have large size by using

both conventional solution growth method and uniaxially solution crystallization method of Sankaranarayanan-Ramasamy.

1.2.2 Growth of pure, L-arginine and glycine doped ADP crystals by using both conventional solution growth method and uniaxially solution crystallization method of Sankaranarayanan-Ramasamy.

1.2.3 Growth of L-arginine and glycine doped KDP crystals by using both conventional solution growth method and uniaxially solution crystallization method of Sankaranarayanan-Ramasamy.

1.2.4 Characterization of the grown crystals.

### **1.3 Scope and limitation of the study**

1.3.1 Synthesis and growth of both pure and doped ZTC, amino acid doped ADP and KDP seed crystals were carried out using the conventional slow evaporation method.

1.3.2 Growth of larger size crystals was carried out using the uniaxially solution-crystallization method of Sankaranarayanan-Ramasamy.

1.3.3 Characterization of the grown crystals were made by XRD, FTIR and TGA/DSC techniques, together with micro hardness and dielectric properties studies.

### **1.4 References**

Bhat, S.G. and Dharmapakah, S.M. (1998). A new metal-organic crystal: Bismuth thiourea chloride. **Materials Research Bulletin**. 33(6): 833.

Hou, W., Yuan, D., Xu, D., Zhang, N., Yu, W., Liu, M., Sun, S. and Jiang, M. (1993). A new organometallic nonlinear optical material - triallylthiourea

mercury bromide (ATMB) crystal: growth and structure. **Journal of Crystal Growth.** 133(1-2): 71.

Rajasekaran, P., Ushasree, P.M., Jayavel, R. and Ramasamy, P. (2001). Growth and characterization of zinc thiourea chloride (ZTC) : asemiorganic non-linear optical crystal. **Journal of Crystal Growth.** 229(1-4): 563.

Roshan , A., Joseph, C. and Ittyachen, M.A. (2001). Growth and characterization of a new metal-organic crystal: Potassium thiourea bromide. **Materials Letters.** 49(5): 299.

Sankaranarayanan, K. and Ramasamy, P. (2005). Unidirectional seeded single crystal growth from solution of benzophenone. **Journal of Crystal Growth.** 280(3-4): 467.

Selvaraju, K., Valluvan, R. and Kumararaman, S. (2007). A new metal-organic crystal: Potassium thiourea chloride. **Materials Letters.** 61(3): 751.

Venkataramanan, V., Maheswaran, S., Sherwood, J.N. and Bhat, H.L. (1997). Crystal growth and physical characterization of the semiorganic bis(thiourea) cadmium chloride. **Journal of Crystal Growth.** 179(3-4): 605.



# CHAPTER II

## REVIEW OF THE LITERATURE

### 2.1 Nonlinear optical materials

Nonlinear optics is the branch of optics that describes the behavior of light in nonlinear media, that is, media in which the polarization  $\mathbf{P}$  responds nonlinearly to the electric field  $\mathbf{E}$  of the light. This nonlinearity is typically only observed at very high light intensities such as those provided by pulsed lasers. In fact, the beginning of the field of nonlinear optics is often taken to be the discovery of second harmonic generation (SHG) by Franken et al. in 1961, shortly after the demonstration of the first working laser by Maiman in 1960 (Boyd, 2003). Nonlinear optics is a very useful technology because it extends the usefulness of lasers by increasing the number of wavelengths available. Wavelengths both longer and shorter than the original can be produced by nonlinear optical material. A number of nonlinear optical phenomena can be described as frequency-mixing processes. If the induced dipole moments of the material respond instantaneously to an applied electric field, the magnitude of the induced polarization (dipole moment per unit volume)  $P(t)$  at time  $t$  in a medium depends on the applied field  $E(t)$ . The expansion of  $P(t)$  in a series of powers of  $E(t)$  is given by :

$$P(t) = \chi^{(1)} E(t) + \chi^{(2)} E^2(t) + \chi^{(3)} E^3(t) + \dots \quad (2.1)$$

$$P(t) = P^{(1)}(t) + P^{(2)}(t) + P^{(3)}(t) + \dots \quad (2.2)$$

Here, the coefficients  $\chi^{(n)}$  are the  $n$ -th order susceptibilities of the medium. For any three-wave mixing process, the second-order term is crucial; it is only nonzero in media that have no inversion symmetry. If a laser beam whose electric field strength is represented as :

$$E(t) = E_1 e^{-i\omega_1 t} + E_2 e^{-i\omega_2 t} + c.c \quad (2.3)$$

is incident upon a crystal for which the second-order susceptibility  $\chi^{(2)}$  is nonzero (c.c. denotes the complex conjugate) , the nonlinear polarization that is created in such a crystal is given as

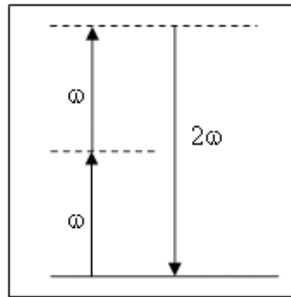
$$\begin{aligned} P^{(2)}(t) = \chi^{(2)} [ & E_1^2 e^{-2i\omega_1 t} + E_2^2 e^{-2i\omega_2 t} + 2E_1 E_2 e^{-i(\omega_1 + \omega_2)t} \\ & + 2E_1 E_1^* e^{-i(\omega_1 - \omega_2)t} + c.c.] + 2\chi^{(2)} [E_1 E_1^* + E_2 E_2^*] \end{aligned} \quad (2.4)$$

The complex amplitudes of the various frequency components of the nonlinear polarization correspond to the second harmonic generation (SHG) of  $E_1$ , the second harmonic generation of  $E_2$ , the sum frequency generation (SFG), the difference frequency generation (DFG), and the optically rectified (OR) signals of  $E_1$  and  $E_2$ . Three wave-mixing gives rise to phenomena like the second harmonic generation, optical rectification, optical parametric oscillation, sum and difference frequency generation.

Under proper experimental conditions, the process of second-harmonic generation can be so efficient that nearly all of the power in the incident radiation at frequency  $\omega$  is converted to radiation at the second-harmonic frequency  $2\omega$ . One common use of second-harmonic generation is to convert the output of a fixed-frequency laser to a different spectral region. For example, the Nd:YAG laser operates in the near infrared at a wavelength of  $1.06 \mu\text{m}$ . Second-harmonic gen-

eration is routinely used to convert the wavelength of the radiation to  $0.53 \mu\text{m}$ , in the middle of the visible spectrum. Second-harmonic can be visualized by considering the interaction in terms of the exchange of photons between the various frequency components of the field.

According to this picture, which is illustrated in Figure 2.1, two photons of frequency  $\omega$  are destroyed and a photon of frequency  $2\omega$  is simultaneously created in single quantum-mechanical process. The solid line in the figure represents the atomic ground state, and the dashed lines represent what are known as virtual levels. These levels are not energy eigen levels of the free atom, but rather represent the combined energy of one of the energy eigenstates of the atom and of one or more photons of the radiation field.



**Figure 2.1** Energy-level diagram describing second-harmonic generation.

Suitable nonlinear crystals are required to have laser sources at new optical wavelengths. The main requirements of nonlinear crystals are large  $\chi^{(2)}$ , phase matchability, wide transmission bandwidth and high laser damage threshold.

Materials that exhibit second-order susceptibility have distinct dipoles. These dipoles are usually permanent, although a second-order effect may be developed with transient dipoles that have a lifetime longer than the period of the wave. The dipoles can result from the formation of crystals with no center of inversion symmetry or from the breakdown of center of inversion symmetry in isotropic ma-

terials by the introduction of anisotropic structures or defects that can be aligned by poling (Simmons and Potter, 2000).

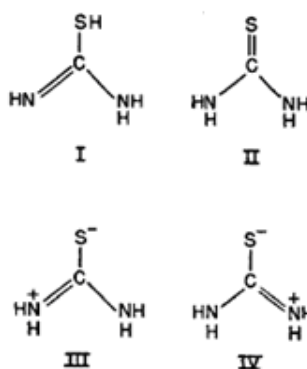
It is already known that there are various physical mechanisms which may cause nonlinear polarization responses in the medium (He and Liu, 1999).

1. Distortion of electronic cloud.
2. Intramolecular motion.
3. Molecular reorientation
4. Induced acoustic motion
5. Induced population change

In different conditions of the applied optical field or for different media, the relative contributions from various mechanisms can be significantly different. The presence of anisotropy in the propagation characteristics of the materials means that the applied electric field and the polarization are not necessarily parallel. The electric field displacement vector ( $\mathbf{D}$ ) remains normal to the propagation vector. Mathematically, this means that the dielectric constant must become a tensor. The tensor is symmetric, so it may be diagonalized into principal dielectric constants along eigenvectors or principal directions, and the wave propagates at different velocities for polarizations along these directions. (Simmons and Potter, 2000). Crystal engineering of new nonlinear optical materials, structures and devices with enhanced figures of merit has developed over the last three decades as a major force to help drive nonlinear optics from the laboratory to real applications. The research of large quadratic susceptibilities  $\chi^{(2)}$  depending on the quasi-perfect packing of highly polarizable molecules in the crystal network has been the main challenge (Zyss and Nicoud, 1996; Meredith, 1983).

## 2.2 Thiourea and metal-organic materials

Thiourea is an organic compound of carbon, nitrogen, sulfur and hydrogen, with the formula  $\text{CSN}_2\text{H}_4$  or  $(\text{NH}_2)_2\text{CS}$  (Figure 2.2). It is similar to urea, except that oxygen atom is replaced by a sulfur atom. The properties of urea and thiourea differ significantly because of the relative electronegativities of sulfur and oxygen. Thiourea is a versatile reagent in organic synthesis. “Thioureas” refers to a broad class of compounds with the general structure  $(\text{R}^1\text{R}^2\text{N})(\text{R}^3\text{R}^4\text{N})\text{C}=\text{S}$ . Thioureas are related to thioamides, e.g.  $\text{RC}(\text{S})\text{NR}_2$ , where R is methyl, ethyl, etc.



**Figure 2.2** Structure of thiourea (Stewart, 1957).

Thiourea molecule has large dipole moment (Bornsten et al., 1982) and has ability to form extensive network of hydrogen bonds. The second-order nonlinear optical interactions can occur only in noncentrosymmetric crystals, that is, in crystals that do not display inversion symmetry. Since liquids, gases, amorphous solids (such as glass), and even many crystals do display inversion symmetry,  $\chi^{(2)}$  vanishes identically for such media, and consequently they cannot produce second-order nonlinear optical interactions. On the other hand, third-order nonlinear optical interactions can occur both for centrosymmetric and noncentrosymmetric media (Boyd, 2003). The centrosymmetric thiourea molecule, when combined with inorganic salts yields noncentrosymmetric complexes, which has nonlinear optical

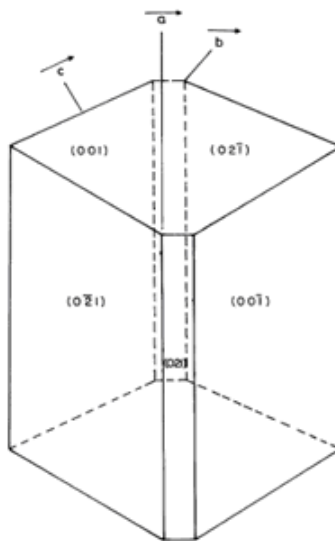
properties (Roshan et al., 2001). Metal complexes of thiourea, commonly called semi-organics, include the advantages of both organic and inorganic part of the complex. A variety of crystals of this class has been grown by several groups (Venkataramanan et al., 1997; Bhat and Dharmaprabah, 1998).

### 2.3 Metal complexes of thiourea

KDP group of materials (inorganic materials) remain the most widely used crystals for frequency conversion because of its inherent nonlinearities. Much recent works have demonstrated that organic crystals can have very large nonlinear susceptibilities compared with inorganic crystals, but their use is impeded by their low optical transparencies, poor mechanical properties and low laser damage thresholds. Purely inorganic NLO materials typically have excellent mechanical and thermal properties but possess relatively modest optical nonlinearities. Hence new types of NLO materials have been built from organic-inorganic complexes in which the high optical nonlinearity of a pure organic compound is combined with the favorable mechanical properties of inorganic materials.

Recently the metal complexes of thiourea have been explored. Some of the examples of these complexes are Zinc Thiourea Sulfate (ZTS), Zinc Thiourea Chloride (ZTC), Bisthiourea Cadmium Chloride (BTCC) and Copper Thiourea Chloride (CTC). These crystals have better nonlinear optical properties than KDP (Rajsekaran et al., 2003; Ushashree et al., 2000; Mary and Dhanuskodi, 2001). Zinc Thiourea chloride is a potential semiorganic nonlinear material and crystallizes in the noncentrosymmetric orthorhombic space group Pnma. Growth of ZTC single crystals using slow evaporation technique at room temperature has been reported. The SHG efficiency of ZTC is reported to be less than that of ZTS (Rajasekaran et al., 2001). Figure 2.3 shows morphology of ZTC crystals grown

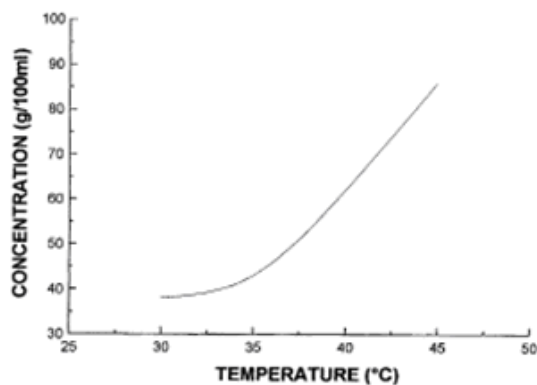
at pH 4.5 by Rajasekaran, Ushasree, Jayavel and Ramasamy.



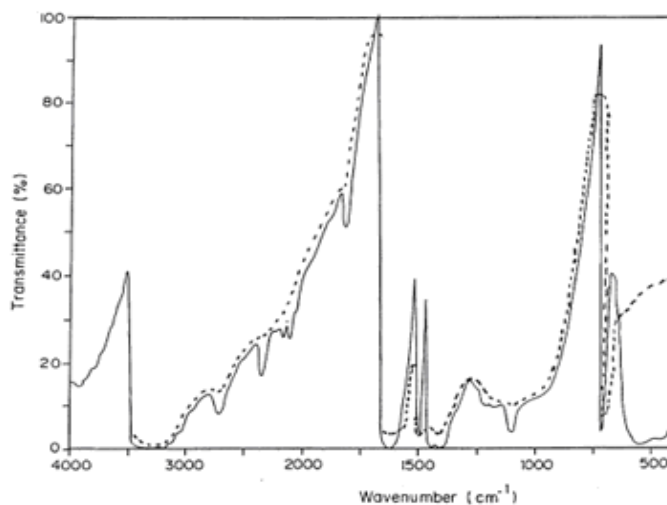
**Figure 2.3** Morphology of ZTC crystals grown at pH 4.5 (Rajasekaran et al., 2001).

ZTC single crystals have been grown from low temperature solution growth method by slow cooling. It has been found that the solution pH influences the growth rate of the crystal along  $[001]$  and  $[010]$  directions. FTIR spectra revealed that the coordination in the crystal occurs through the sulfur. Transmission spectra revealed that the crystal has an extended transparency down to UV. Thermogravimetric analysis showed that ZTC is thermodynamically stable up to 225 °C. The hardness values of ZTC were comparable to other semi-organic crystals. Figure 2.4 shows the solubility curve for ZTC at different temperatures. The promising crystal growth characteristics and the properties of ZTC crystal prove it to be an attractive material for harmonic generation of Nd:YAG lasers (Rajasekaran et al., 2001). The FTIR spectrum of ZTC is shown in Figure 2.5.

Metal complexes of thiourea exhibit variety of structural phase transitions as thiourea exhibits ferroelectric phase to an incommensurate structure (Cienninski et al., 1990) and the properties also depend on the nature of the host in which



**Figure 2.4** Solubility curve for ZTC at different temperatures (Rajasekaran et al., 2001).



**Figure 2.5** FTIR spectrum of ZTC (Rajasekaran et al., 2001).

thiourea molecule complexes in.

## 2.4 Amino acid doped KDP crystals

Nonlinear optical materials are needed to realize applications in telecommunication, optoelectronics and laser technology. NLO crystals continue to be interesting materials both academically and industrially. NLO crystals with high conversion efficiencies for second harmonic generation are desirable in various ap-



plications. The very first material to be used and exploited for their nonlinear optical and electro-electrical properties was potassium dihydrogen phosphate. It has the tetramolecular unit cell, having the unit cell parameters,  $a = b = 7.448 \text{ \AA}$  and  $c = 6.977 \text{ \AA}$  (Wyckoff, 1960). KDP is a dielectric material well known for its electro optical (ferroelectric at low temperature:  $T_c = 123 \text{ K}$ ) and nonlinear optical properties. The excellent properties of KDP include transparency in a wide region of optical spectrum, resistance to damage by laser radiation and relatively high nonlinear efficiency. Therefore, it is commonly used in several applications such as laser fusion and frequency conversion. In addition, KDP crystal exhibits pyroelectric effect and is used in infrared imaging. Many studies on the growth and properties of KDP crystals in the presence of impurities have been reported (Wang, et al., 2006; Kannan et al., 2006; Podder et al., 2001). The KDP is a transparent dielectric material best known for its nonlinear optical and electro optical properties. The demand for high quality large KDP single crystal increases due to its application as frequency conversion crystal in confinement fusion. These crystals are required to have good optical property and high laser damage threshold. Additives have an important role in improving the qualities of KDP crystal and the effect on the adjustment of growth habits. Pure and impurity added KDP single crystals have been grown from aqueous solutions and characterized by different workers (Kannan et al., 2006; Podder et al., 2001).

Some interesting results have already been reported on several properties of impurity added KDP single crystals. KDP doped with amino acids like L-arginine and glycine by conventional solution method were reported by Kumar and Babu. Transparent, colorless crystals of pure, L-arginine and glycine doped KDP single crystals were grown by slow evaporation technique at constant temperature ( $35^\circ\text{C}$ ). Amino acid doped crystals have shown an increase in Second Harmonic Generation

efficiency compared to pure KDP crystals (Kumar and Babu, 2008).

## 2.5 Amino acid doped ADP crystals

Ammonium dihydrogen phosphate and potassium dihydrogen phosphate are two of the oldest crystals grown in large size for many applications and continue to be interesting materials both academically and industrially (Tukubo and Makita, 1989).

ADP crystal is very interesting due to its piezo-electric property and non-linear optical property. ADP belongs to scalenohedral (twelve faced) class of tetragonal crystal system. It has the tetramolecular unit cell, having the unit cell parameters,  $a = b = 7.510 \text{ \AA}$  and  $c = 7.564 \text{ \AA}$  (Wyckoff, 1960). Because of its interesting electrical and optical properties, structural phase transitions, and ease of crystallization, it has been the subject of a wide variety of investigations for over 50 years (Li et al., 2001; Meena and Mahadevan, 2008; Xu and Xue, 2006). With the aim of discovering new useful materials for academic and industrial use, an attempt has been made to modify ADP crystals by adding some amino acids. Since most of the amino acids exhibit NLO property, it is expected that the addition of some amino acids, such as L-arginine and glycine, in ADP could also improve the various properties. L-arginine was attempted as the dopant to reduce  $\epsilon_r$  value of ADP crystals and decrease of  $\epsilon_r$  value due to L-arginine addition indicates the possibility of making ADP crystals the low  $\epsilon_r$  value dielectrics that may be very useful for microelectronics industry (Meena and Mahadevan, 2008).

## 2.6 Conventional and Sankaranarayanan-Ramasamy solution growth methods

There are several techniques for crystallization which can be classified according to their phase transformation as

1. Growth from solid : solid-solid phase transformation
2. Growth from liquid : liquid-solid phase transformation
3. Growth from vapour : vapour-solid phase transformation

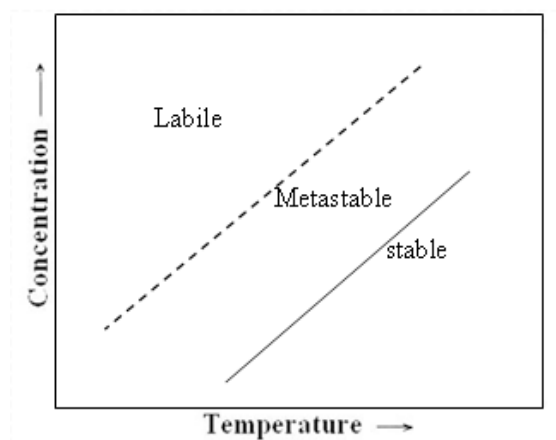
Growth from solution, in particular the low temperature solution growth, occupies an outstanding position due to its versatility and simplicity. Growth from solution occurs close to equilibrium conditions and hence crystals of high perfection can be grown. Since this thesis involves the work on growing crystals from low temperature solutions, the processes of low temperature solution growth methods are briefly discussed. The method of crystal growth from low temperature aqueous solutions is extremely popular in the production of many technologically important crystals.

Low temperature solution technique can be subdivided into the following methods,

1. Slow cooling method
2. Solvent evaporation method
3. Temperature gradient method

In order to grow crystals, the solution must be supersaturated. Supersaturation of a system is the driving force, which governs the rate of crystal growth. A typical solubility diagram is shown in Figure 2.6. The whole concentration-temperature field is separated by solubility curve into two regions; undersaturated and supersaturated solutions. The solubility of most substances increases with

temperature. Crystal can be grown only from supersaturated solution. The region of supersaturated solution can be divided into two sub-regions; metastable and labile zones. Nucleation will occur spontaneously in the labile zone. Metastable Zone refers to the level of supersaturation where spontaneous nucleation cannot occur and seed crystal is essential to crystal growth. In slow cooling technique, supersaturation is achieved by a change in temperature usually throughout the entire crystallizer. The crystallization process is carried out in such a way that the point on the temperature-dependence of the concentration moves into the metastable region along the saturation curve in the direction of lower solubility. In the solvent evaporation method, the vapour pressure of the solvent above the solution is higher than the vapour pressure of the solute and, therefore, the solvent evaporates more rapidly and solution becomes supersaturated (Santharaghavan and Ramasamy, 2000).



**Figure 2.6** Solubility Diagram (Santharaghavan and Ramasamy, 2000).

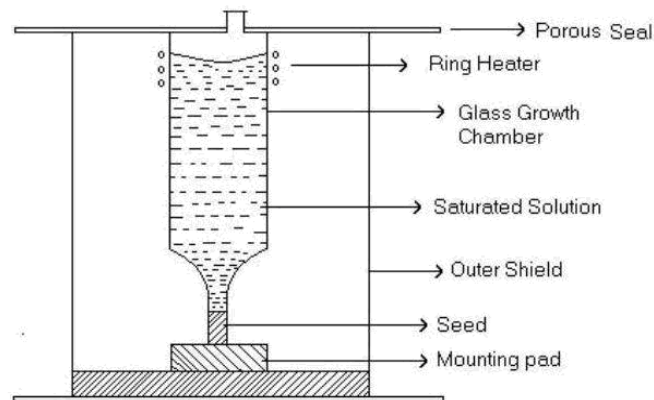
A newly discovered novel method called “Sankaranarayanan-Ramasamy (SR) method” gives bulk unidirectional crystals with good quality from solution (Sankaranarayanan and Ramasamy, 2005). The growth of bulk size crystals without defects is a challenging task for crystal grower. Also, for SHG applications we

need phase matchable crystals. The SR solution growth technique is suitable to get unidirectional crystals from solution. The main advantages of SR solution growth technique are simple experimental set-up, unidirectional growth, high solute-solid conversion, minimum thermal stress on the crystal during growth and prevention of microbial growth. Also, the growth rate of different planes can be measured (Babu et al., 2006).

A relation can be given for the growth rate for the SR method based on the solubility of the material, evaporation rate, size of the growth vessel and the density of the material (Balamurugan and Ramasamy, 2006).

$$R(T) = 0.318k.(SE)/r^2d(\text{cm/day}) \quad (2.5)$$

where  $k$  is the proportionality constant,  $S$  is the solubility of the material (g/mL of solvent),  $E$  is the evaporation rate of solvent (mL/day),  $r$  is the radius of the vessel (for cylindrical)(cm),  $d$  is the density of the material (g/cm<sup>3</sup>), and  $T$  is the temperature (K).



**Figure 2.7** Schematic diagram of the experimental set-up (Sankaranarayanan and Ramasamy, 2005).

The schematic diagram of experimental set-up is shown in Figure 2.7. It

consists of a growth ampoule made out of glass with seed mounting pad. An outer glass shield tube protects and holds the inner growth ampoule. A ring heater positioned at the top of the growth ampoule was connected to the temperature controller and it provides the necessary temperature for solvent evaporation. The temperature around the growth ampoule was selected based on the solvent used and was controlled with the aid of temperature controller (Sankaranarayanan and Ramasamy, 2005). In the original form of the SR method set-up, depending on the growth rate of the crystal, the ring heater was moved downwards using a translation mechanism. It is difficult to translate the heater at the rate of crystal growth. SR method is modified in some aspects and used for growth of triglycine sulphate (TGS) crystal. The modification leads to the simplicity, reduction of cost and avoided the temperature fluctuations (Balamurugan et al., 2007). The ring heater is not translated but fixed on the top of the ampoule. The crystallizer was kept in a water bath to avoid the temperature fluctuation of the daily variation.

## 2.7 References

- Babu, R.R., Sethuraman, K., Gopalakrishnan, R. and Ramasamy, P. (2006). Growth of L-lysine monohydrochloride dihydrate bulk single crystal by Sankaranarayanan-Ramasamy (SR) method. **Journal of Crystal Growth.** 297(2): 356.
- Balamurugan, N. and Ramasamy, P. (2006) Investigation of the growth rate formula and bulk laser damage threshold KDP crystal growth from aqueous solution by the Sankaranarayanan-Ramasamy (SR) method. **Crystal Growth Design.** 6(7): 1642.
- Balamurugan, N, Lenin, M., Bhagavannarayana, G. and Ramasamy, P. (2007)

- Growth of TGS crystals using uniaxially solution-crystallization method of Sankaranarayanan-Ramasamy. **Crystal Research and Technology**. 42(2): 151.
- Bhat, S.G. and Dharmaprabah, S.M. (1998). A new metal-organic crystal: Bismuth thiourea chloride. **Materials Research Bulletin**. 33(6): 833.
- Bornsten, L., Hellwege, K.H. and Hellwege, A.M. (1982). **Numerical Data and Functional Relationships in Science and Technology Group II**. Berlin. Springer Verlag.
- Boyd, R.W. (2003). **Nonlinear optics**. (2nd ed.). London. Academic press.
- He, G.S. and Liu, S.H. (1999). **Physics of Nonlinear optics**. Singapore. World Scientific.
- Kannan, V., Ganesh, R.B., Sathyalakshmi, R, Rajesh, N.P. and Ramasamy, P. (2006). Investigation of  $\text{La}^{3+}$  ions on growth and NLO properties of KDP single crystals. **Crystal Research and Technology**. 41(7): 678.
- Kumar, B.S. and Babu, K.R. (2008). Effect of L-arginine and glycine on the growth of KDP single crystals and their characterization. **Indian Journal Pure and Applied Physics**. 46: 123.
- Li, Z., Huang, X., Wu, D. and Xiong, K. (2001). Large crystal growth and measurement of electro-optical coefficients of ADP. **Journal of Crystal Growth**. 222(3): 524.
- Mary, P.A.A. and Dhanuskodi, S. (2001). Growth and characterization of a new nonlinear optical crystal : Bis thiourea zinc chloride. **Crystal Research and Technology**. 36(11): 231.

- Meena, M. and Mahadevan, C.K. (2008). Growth and electrical characterization of L-arginine added KDP and ADP single crystals. **Crystal Research and Technology**. 43(2): 166.
- Meredith, G.R. (1983). **Nonlinear Optical Properties of Organic and Polymeric Materials**. (2nd ed.). (n.p.). ACS Symposium Series.
- Podder, J., Ramalingom, S. and Kalkura, S.N. (2001). An investigation on the lattice distortions in urea and KCl doped KDP single crystals by X-ray diffraction studies. **Crystal Research and Technology**. 36(6): 549.
- Rajsekaran, R., Rajendiran, K.V., Kumer, R.M., Jayavel, R., Dhanasekaran, R. and Ramasamy, P. (2003). Investigation on the nucleation kinetics of zinc thiourea chloride (ZTC) single crystals. **Materials Chemistry and Physics**. 82(2): 273.
- Rajasekaran, P., Ushasree, P.M., Jayavel, R. and Ramasamy, P. (2001). Growth and characterization of zinc thiourea chloride (ZTC) : a semiorganic non-linear optical crystal. **Journal of Crystal Growth**. 229(1-4): 563.
- Roshan, A., Joseph, C. and Ittyachen, M.A. (2001). Growth and characterization of a new metal-organic crystal: Potassium thiourea bromide. **Materials Letters**. 49(5): 299.
- Sankaranarayanan, K. and Ramasamy, P. (2005). Unidirectional seeded single crystal growth from solution of benzophenone. **Journal of Crystal Growth**. 280(3-4): 467.
- Santharaghavan, P. and Ramasamy, P. (2000). **Crystal growth processes and methods**. India. KRU publications.



- Simmons, J.H. and Potter, K.S. (2000). **Optical Materials**. London. Academic Press.
- Stewart, J.E. (1957). Infrared absorption spectra of urea, thiourea and some thiourea-alkali halide complexes. **Journal of Chemical Physics**. 26: 253.
- Tukubo, H. and Makita, H. (1989). Refractometric studies of  $\text{NH}_4\text{H}_2\text{PO}_4$  and  $\text{KH}_2\text{PO}_4$  solution growth; experimental set-up and refractive index data. **Journal of Crystal Growth**. 94(2): 469.
- Ushasree, P.M., Murlidharan, R., Jayavel, R. and Ramasamy, P. (2000). **Journal of Crystal Growth**. 218(2-4): 365.
- Venkataramanan, V., Maheswaran, S., Sherwood, J.N. and Bhat, H.L. (1997). Crystal growth and physical characterization of the semiorganic bis (thiourea) cadmium chloride. **Journal of Crystal Growth**. 179(3-4): 605.
- Von Cienninski, J., Sorge, G., Magatayev, V.K. and Shuvalov, L.A. (1990). **Ferroelectrics**. 105: 261.
- Wang, B., Fang, Ch., Wang, Sh., Sun, X., Li, Q.G.Y., Xu, X., Zhang, J., Liu, B. and Mou, X. (2006). The effect of  $\text{Sn}^{4+}$  ion on the growth habit and optical properties of KDP crystal. **Journal of Crystal Growth**. 297(2): 352.
- Wyckoff, R.W.G. (1960). **Crystal structures**. (Vol.3). (2nd ed.). New York. Interscience.
- Xu, D. and Xue, D. (2006) Chemical bond analysis of the crystal growth of KDP and ADP. **Journal of Crystal Growth**. 286(1): 108.

Zyss, J. and Nicoud, J.F. (1996). Status and perspective for molecular nonlinear optics: from crystals to polymers and fundamentals to applications. **Current Opinion in Solid State and Materials Science**. 1: 533.

# CHAPTER III

## GROWTH AND CHARACTERIZATION OF THE PURE AND K<sup>+</sup> DOPED ZINC THIOUREA CHLORIDE CRYSTALS

### 3.1 Abstract

Pure and K<sup>+</sup> doped single crystals of Zinc Thiourea Chloride were grown by slow solvent evaporation technique and large size single crystals of pure ZTC were grown by Sankaranarayanan-Ramasamy technique. Powder XRD studies of both pure and doped samples were carried out and the results were compared. FTIR studies were performed to identify the presence of various functional groups in the grown crystals. The optical absorption analysis revealed that the pure and 0.2 mole % of K<sup>+</sup> doped ZTC crystals have very low percentage of absorption in the entire visible region. Dielectric constants of both pure and doped samples were measured. The good dielectric properties show that the ZTC crystal grown by SR technique may be useful for variety of NLO applications.

### 3.2 Introduction

Nonlinear optical frequency conversion materials have a significant impact on laser technology, optical communication and optical storage technology. The search for new NLO materials over the past decade has led to the discovery of many organic NLO materials with high nonlinear susceptibilities. However, their

practical applications are limited by poor optical quality, lack of robustness, low laser damage threshold properties (Hou et al., 1993) and difficulties still remain in crystal growth with sufficient quality and hardness for applications, such as optical and electro-optical sampling devices.

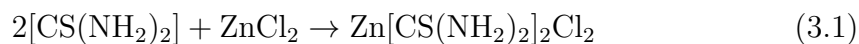
The approach of combining the high nonlinear optical coefficients of the organic molecules with the excellent physical properties of inorganics has been found to be overwhelmingly successful in the recent past. Thiourea, which is otherwise centrosymmetric, yields excellent noncentrosymmetric materials and typifies this approach (Venkataramanan et al., 1997).

Metal complex of thiourea, commonly called semi-organics, include the advantages of both organic and inorganic part of the complex. A variety of crystals of this class has been grown by several groups (Bhat and Dharmaparakah, 1998; Selvaraju et al., 2007). The growth of single crystals of potassium thiourea chloride was accomplished by the slow evaporation solution growth method. PTC has good optical transmission in the entire visible region, which is an essential requirement for a nonlinear crystal (Selvaraju et al., 2007). Growth of pure zinc thiourea chloride crystals has been carried out by slow evaporation solution method (Roshan et al., 2001). Transmission spectra of ZTC revealed that the crystal has an extended transparency down to UV. The hardness values of the ZTC crystals were comparable to other semi-organic crystals. The promising crystal growth characteristics and the properties of the ZTC crystal prove it to be an attractive material for harmonic generation of Nd:YAG lasers (Roshan et al., 2001; Rajasekaran et al., 2001), The present work deals with the growth, optical absorption, XRD, FTIR and dielectric studies of pure and  $K^+$  doped ZTC single crystals.

### 3.3 Experimental

#### 3.3.1 Material preparation

ZTC was synthesized by dissolving thiourea and zinc chloride in the molar ratio 2:1 in deionized water. ZTC was synthesized according to the relation

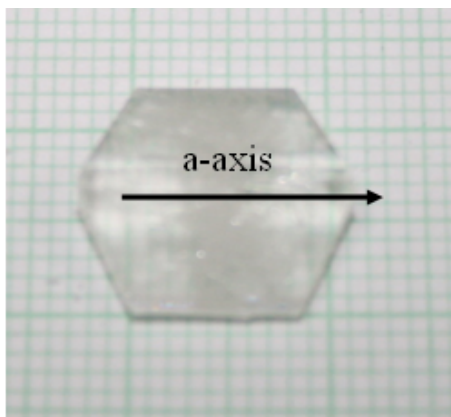


#### 3.3.2 Crystal growth by the conventional slow evaporation technique

The synthesized salt was dissolved in deionized water. The solution was in slightly undersaturation condition. The solution was constantly stirred for 6 hr using magnetic stirrer. The solution was filtered using No.1 whatman filter paper. Then the solution was poured in a different beaker in the water-bath with constant temperature at 35°C. Seed crystals were formed due to spontaneous nucleation. A seed crystal grown in 1 week is shown in Figure 3.1. Good quality seed crystals were taken for growing large size crystals by both the conventional and SR techniques. The crystals were grown by slow solvent evaporation method. K<sup>+</sup> doped ZTC crystals were also grown by doping 0.2, 1.0 and 2.0 mole % of KCl.

#### 3.3.3 Crystal growth of the pure ZTC by the SR method

Sankaranarayanan and Ramasamy found a technique to grow unidirectional crystal from solution and have successfully grown benzophenone single crystals with different orientation (Sankaranarayanan, 2005; Sankaranarayanan and Ramasamy, 2006) We have employed this technique to grow pure ZTC single crystals.



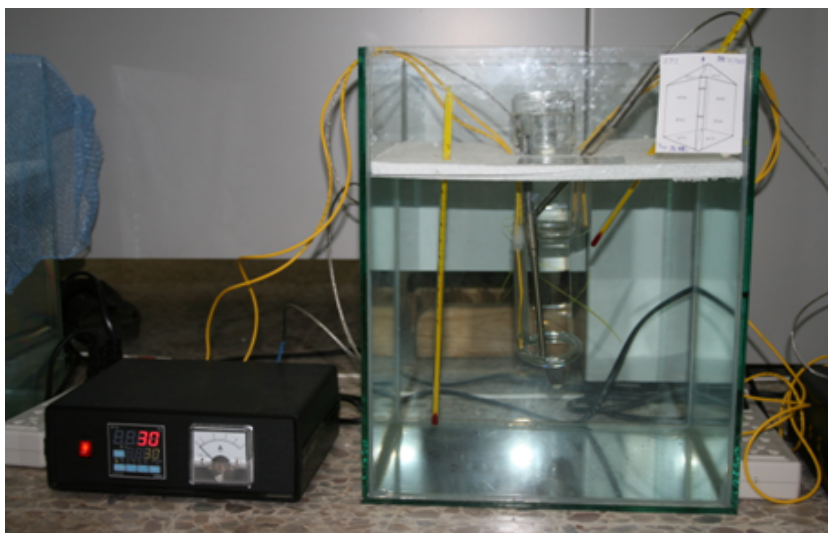
**Figure 3.1** The pure ZTC seed crystal grown in 1 week.

It consists of two heating coils placed at the top and the bottom of the crucible in the water bath and they are directly connected to thermostat to maintain the heating voltage (Figure 3.2). Growth condition of this method depends on the temperatures of heating coils. The a-axis of the seed crystal was selected for unidirectional crystal growth. A seed crystal obtained in the previous section was mounted at the bottom of the crucible. The temperature difference between the top and bottom heating coils was carefully maintained. After a time span of 60 days a good quality single crystal of pure ZTC has been grown successfully with size  $\sim 60$  mm in length and  $\sim 30$  mm in diameter, as shown in Figure 3.3.

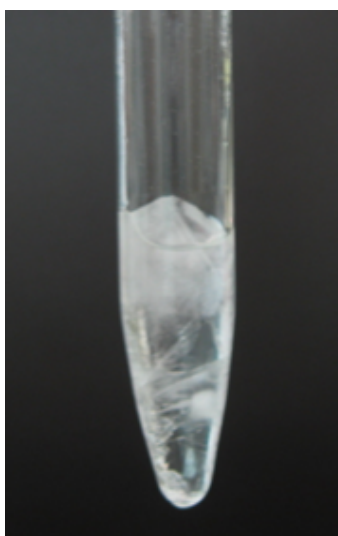
## 3.4 Characterization

### 3.4.1 X-ray diffraction analysis

Powder X-ray diffraction analysis has been carried out using D5005 X-ray diffractometer (Bruker AXS) with  $\text{CuK}\alpha$  ( $\lambda = 1.5418 \text{ \AA}$ ). The sample was scanned over  $10\text{-}70^\circ\text{C}$  at the rate of  $1^\circ\text{C}/\text{min}$ . Figure 3.4 shows the X-ray powder diffractogram of the ZTC crystal. Powder X-ray diffraction studies of the pure ZTC crystals grown by both conventional and SR methods confirmed the orthorhombic



**Figure 3.2** SR method experimental set-up.

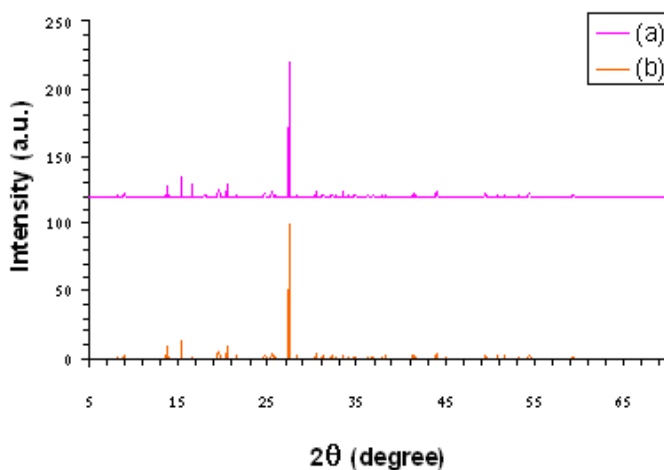


**Figure 3.3** The pure ZTC crystal grown by the SR method.

structure of the grown crystals. In addition, powder x-ray diffraction studies of the ZTC crystals doped with 0.2, 1.0 and 2.0 mole % of  $K^+$  grown by conventional method also confirmed the orthorhombic structure of the grown crystals.

### 3.4.2 FTIR studies

Fourier transform spectroscopy is a simple mathematical technique to resolve a complex wave into its frequency components. The spectrum was observed from SPECTRUM GX (Perkin Elmer) FTIR spectrophotometer in the regions 1000-4000  $\text{cm}^{-1}$  using a KBr pellet. The FTIR spectrum of the ZTC crystal grown by the conventional method is shown in Figure 3.5. The functional groups of the grown crystals were confirmed.

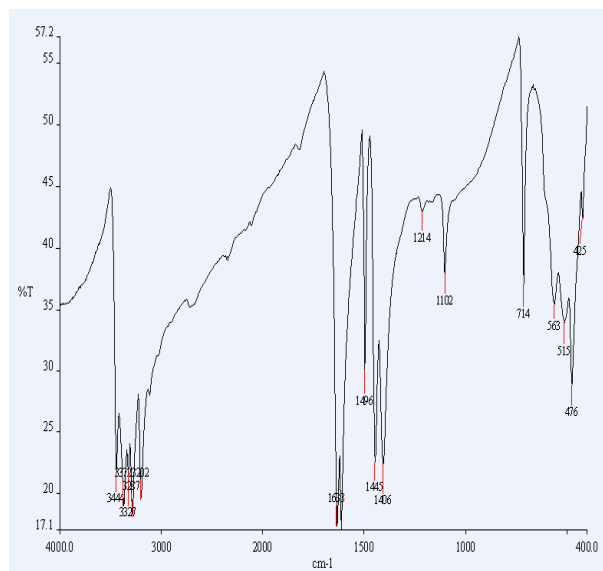


**Figure 3.4** X-ray powder diffractogram of the pure ZTC crystals grown by both conventional (a) and SR (b) methods.

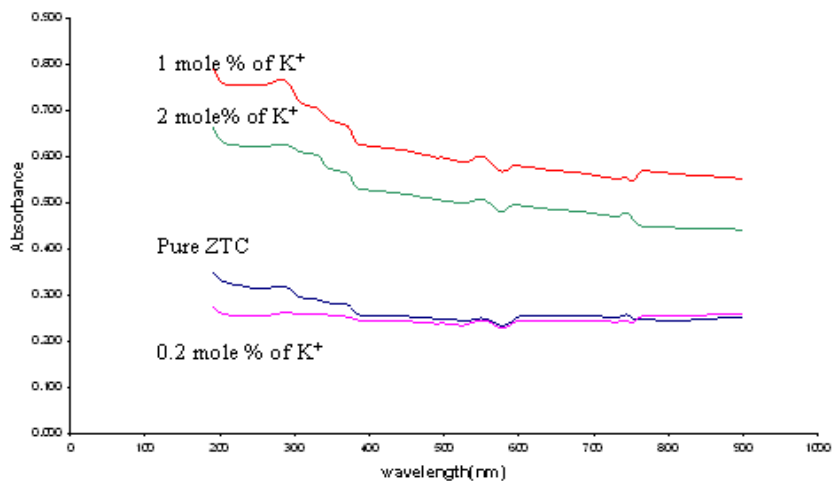
### 3.4.3 Optical property studies

The optical absorption analysis revealed that the pure ZTC and ZTC doped with 0.2 mole % of  $\text{K}^+$  crystals have very low percentage of absorption in the entire visible region, which is a very essential property for NLO crystals. But the ZTC crystals doped with 1.0 and 2.0 mole % of  $\text{K}^+$  have high percentage of absorption.





**Figure 3.5** The FTIR spectrum of the pure ZTC crystals grown by the conventional method.



**Figure 3.6** UV-visible spectra of the pure and  $K^+$  doped ZTC grown by the conventional method.

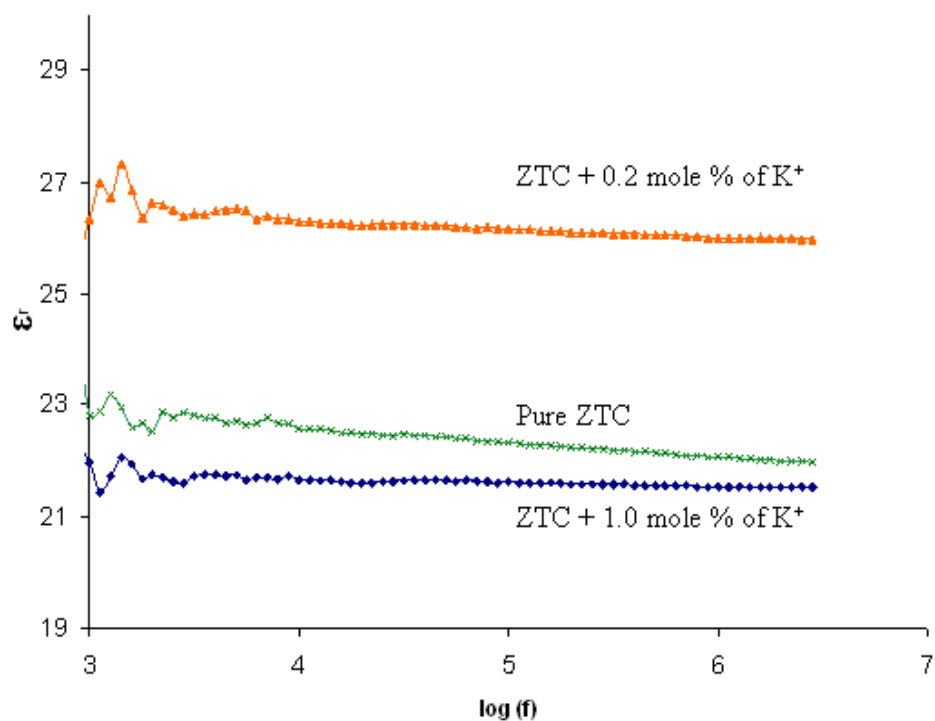
### 3.4.4 Dielectric constant

Dielectric properties are correlated with electro-optic properties of the crystals particularly when they are nonconducting materials. The pure and doped ZTC crystals grown by both conventional and SR techniques have been characterized

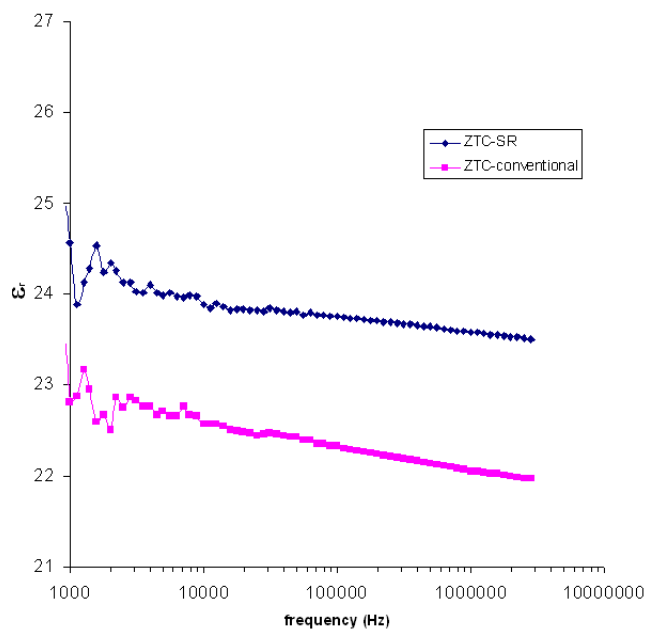
by dielectric constant studies. The plots in Figures 3.8 - 3.9 show the dielectric constant with different frequencies for the grown crystals. The ZTC crystal doped with 0.2 mole % of  $K^+$  has the dielectric constant greater than the pure ZTC crystal, but the dielectric constant of the pure ZTC crystal is greater than the dielectric constant of the ZTC crystal doped with 1.0 mole % of  $K^+$  as shown in Figure 3.8. The dielectric constant of the pure ZTC crystal grown by both conventional and SR techniques were measured and the results are shown in Figure 3.9. The pure ZTC crystal grown by SR method has the dielectric constant greater than the pure ZTC crystal grown by conventional method at all measured frequencies. The plot in Figure 3.10 shows the dielectric loss ( $\epsilon'' = \tan \delta \cdot \epsilon_r$ ) of the pure ZTC crystal grown by the conventional and SR methods at different frequencies. Low dielectric loss at high frequencies indicates that the specimen crystal contains very low density of defects. The dielectric loss of the pure ZTC crystal grown by the SR method is lower than the dielectric loss of pure ZTC crystal grown by the conventional method. The good dielectric properties indicate that the ZTC crystal grown by the SR method may be useful for variety of NLO applications.

### 3.5 Conclusion

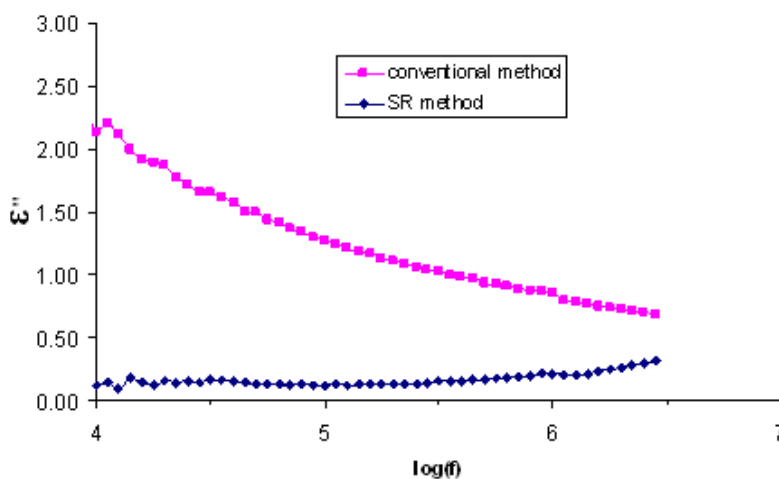
Large size single crystals of pure ZTC have been grown by SR method. The crystal structure and functional groups were confirmed. Good dielectric properties were observed in the present investigations. The optical absorption analysis revealed that the pure ZTC and ZTC doped with 0.2 mole % of  $K^+$  crystals have very low percentage of absorption in the entire visible region, which is a very essential property for NLO crystals. Dielectric measurements indicate that the crystal grown by the SR method has good crystalline perfection and low density of defects.



**Figure 3.7** Dielectric constant of the pure and  $K^+$  doped ZTC crystals grown by the conventional method.



**Figure 3.8** Dielectric constant of the pure ZTC grown by conventional method and SR method.



**Figure 3.9** Dielectric loss ( $\epsilon''$ ) of the pure ZTC crystals grown by conventional and SR techniques.

### 3.6 References

Bhat, S.G. and Dharmaprasah, S.M. (1998). A new metal-organic crystal: Bismuth thiourea chloride. **Materials Research Bulletin**. 33(6): 833.

Hou, W., Yuan, D., Xu, D., Zhang, N., Yu, W., Liu, M., Sun, S. and Jiang, M. (1993). A new organometallic nonlinear optical material - triallylthiourea mercury bromide (ATMB) crystal: growth and structure. **Journal of Crystal Growth**. 133(1-2): 71.

Rajasekaran, R., Kumar, R.M., Jayavel, R. and Ramasamy, P. (2003). Influence of pH on the growth and characteristics of nonlinear optical zinc thiourea chloride (ZTC) single crystals. **Journal of Crystal Growth**. 252(1-3): 317.

Rajsekaran, R., Rajendiran, K.V., Kumer, R.M., Jayavel, R., Dhanasekaran, R. and Ramasamy, P. (2003). Investigation on the nucleation kinetics of

zinc thiourea chloride (ZTC) single crystals. **Materials Chemistry and Physics.** 82(2): 273.

Rajasekaran, P., Ushasree, P.M., Jayavel, R. and Ramasamy, P. (2001). Growth and characterization of zinc thiourea chloride (ZTC) : a semiorganic non-linear optical crystal. **Journal of Crystal Growth.** 229(1-4): 563.

Roshan, A., Joseph, C. and Ittyachen, M.A. (2001). Growth and characterization of a new metal-organic crystal: Potassium thiourea bromide. **Materials Letters.** 49(5): 299.

Sankaranarayanan, K. (2005). Growth of large size 1 1 0 benzophenone crystal using uniaxially solution-crystallization method of Sankaranarayanan-Ramasamy (SR). **Journal of Crystal Growth.** 284(1-2): 203.

Sankaranarayanan, K. and Ramasamy, P. (2005). Unidirectional seeded single crystal growth from solution of benzophenone. **Journal of Crystal Growth.** 280(3-4): 467.

Sankaranarayanan, K. and Ramasamy, P. (2006). Growth of bezophenone crystals from solution: A novel approach with 100% solute-crystal conversion efficiency. **Crystals Research and Technology.** 41(3): 225.

Selvaraju, K., Valluvan, R. and Kumararaman, S. (2007). A new metal-organic crystal: Potassium thiourea chloride. **Materials Letters.** 61(3): 751.

Venkataramanan, V., Maheswaran, S., Sherwood, J.N. and Bhat, H.L. (1997). Crystal growth and physical characterization of the semiorganic bis(thiourea) cadmium chloride. **Journal of Crystal Growth.** 179(3-4): 605.

# CHAPTER IV

## GROWTH AND CHARACTERIZATION OF PURE, L-ARGININE AND GLYCINE DOPED ADP CRYSTALS

### 4.1 Abstract

Single crystals of pure, L-arginine and glycine doped ammonium dihydrogen phosphate were grown by slow solvent evaporation technique and large size single crystals of pure and doped ADP were grown by Sankaranarayanan-Ramasamy technique. Powder XRD studies of the samples were carried out and FTIR studies were performed to identify the presence of various functional groups in the grown crystals. The optical absorption analysis revealed that the pure and doped ADP crystals had very low percentage of absorption in the entire visible region. Dielectric properties of both pure and doped samples were measured. The good dielectric properties indicated that the ADP crystal grown by SR technique may be useful for variety of NLO applications. The DSC and TG curves of the grown crystals indicated that they were stable up to 200°C and larger hardness value for SR method grown crystal confirmed greater crystalline perfection.

### 4.2 Introduction

Materials with large optical nonlinearities are needed to realize applications in optoelectronics, telecommunication industries, laser technology and optical stor-

age devices. Ammonium dihydrogen phosphate and potassium dihydrogen phosphate are two of the oldest crystals grown in large size for many applications and continue to be interesting materials both academically and industrially (Tukubo and Makita, 1989). ADP crystal is of more interest because of its piezo-electric property. This crystal is antiferroelectric and has got non-linear optical property. Due to its interesting electrical and optical properties, structural phase transitions, and ease of crystallization, it has been the subject of a wide variety of investigations for over 50 years (Meena and Mahadevan, 2008). ADP belongs to scalenohedral (twelve faced) class of tetragonal crystal system. It has the tetramolecular unit cell, having the unit cell parameters,  $a = b = 7.510 \text{ \AA}$  and  $c = 7.564 \text{ \AA}$  (Wyckoff, 1960).

NLO single crystals with high conversion efficiencies for second harmonic generation are desirable in various applications. With the aim of discovering new useful materials for academic and industrial use, an attempt has been made to modify ADP crystals by adding some amino acids. Since most of the amino acids exhibit NLO property, it is expected that the addition of some amino acids, such as L-arginine and glycine, in ADP could also improve the various properties (Meena and Mahadevan, 2008). Nevertheless, there have only been very few reports available on the effect of amino acid on the properties of ADP crystals. In this chapter the growth and characterization of L-arginine and glycine doped ADP crystals will be reported. Uniaxial solution crystallization method of Sankaranarayanan-Ramasamy is a novel method to grow single crystals with 100% solute-crystal conversion efficiency (Sankaranarayanan and Ramasamy, 2005; Sankaranarayanan, 2005; Sankaranarayanan and Ramasamy, 2006).

## **4.3 Crystal growth procedure**

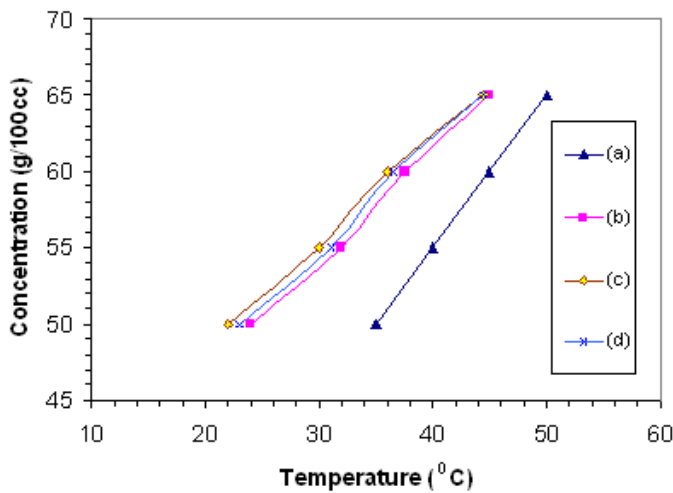
### **4.3.1 Metastable zone studies**

Four hundred millilitres of ADP solution saturated at 35°C was prepared in accordance with the solubility diagram. Then the solution was taken in two beakers each containing 200 ml. In one beaker, 1 mole % of glycine was added. The solutions were filtered using No.1 whatman filter paper. These beakers were loaded in a constant temperature bath. The solutions were stirred continuously for 6 h for stabilization. Then, the temperature of the bath was reduced at the rate of 4°C/h, while stirring the solution continuously. The temperature at which the first speck of the particle was observed corresponds to the width of metastable zone. The experiment was repeated for solution saturated at temperature 40, 45 and 50°C. The metastable zone width for different saturation temperatures of pure, glycine and L-arginine added solutions is shown in Figure 4.1. It is seen that the zone width decreases as the temperature increases in the case of both pure, glycine and L-arginine added solutions. Metastable zone width studies are helpful to grow good quality crystals.

### **4.3.2 Crystal growth by the conventional slow evaporation technique**

Analytical reagent grade samples of ADP, L-arginine and glycine along with de-ionized water were used for the growth of single crystals. The solution was in slightly undersaturation condition. The solution was constantly stirred for 6 h using magnetic stirrer for homogenization. The pure and doped ADP solution was filtered using No.1 whatman filter paper. Then the solution was poured into a different beaker in the water-bath with constant temperature at 35°C. The product



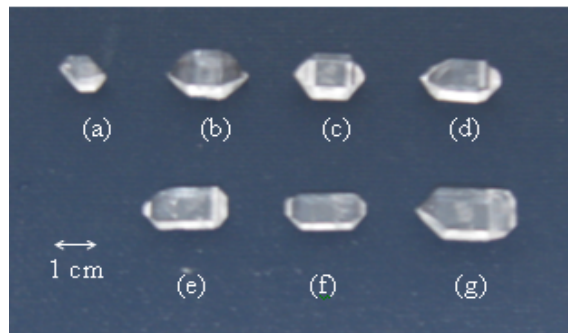


**Figure 4.1** Solubility curve (a), Metastability limit of pure ADP (b), 1 mole % glycine doped ADP (c) and 1 mole % L-arginine doped ADP(d).

was purified by repeated recrystallization, typically thrice from de-ionized water. ADP crystals doped with L-arginine and glycine of different mole concentrations (1 mole %, 2 mole % and 3 mole %) have been crystallized by the low temperature solution growth technique at 35°C in about two weeks. Seed crystals of pure and doped ADP were formed due to spontaneous nucleation. Tiny crystals with good transparency, well defined shape were selected as seeds to grow bulk crystals by both conventional and SR methods. Best seed crystals of respective doping were selected and placed in appropriate solution for growth. The vessel containing the solution was kept in a constant temperature bath at 35°C to allow slow evaporation of the solvent. Single crystals grown in 2 weeks are shown in Figure 4.2.

### 4.3.3 Crystal growth of the pure and doped ADP by the SR method

Sankaranarayanan and Ramasamy found a technique to grow unidirectional crystal from solution and have successfully grown benzophenone single crystals



**Figure 4.2** ADP crystals grown from aqueous solutions containing different concentrations of L-arginine : (a) 0 mole %, (b) 1 mole %, (c) 2 mole %, (d) 3 mole %, and different concentrations of glycine: (e) 1 mole %, (f) 2 mole %, (g) 3 mole %.

with different orientations (Sankaranarayanan and Ramasamy, 2005; Sankaranarayanan, 2005; Sankaranarayanan and Ramasamy, 2006). We have employed this technique to grow pure, glycine and L-Arginine doped ADP single crystals. The system consisted of two heating coils placed at the top and the bottom of the crucible in the water bath and directly connected to thermostat to maintain the heating voltage. Growth condition of this method depended on the temperatures of heating coils. The  $\langle 001 \rangle$  direction of the seed crystal was selected for unidirectional crystal growth. A seed crystal obtained in the previous section was mounted at the bottom of the crucible. The temperature difference between the top and bottom heating coils was carefully maintained. After a time span of 60 days, good quality single crystals of pure and doped ADP were grown successfully with the size of  $\sim 50$  mm in length and  $\sim 20$  mm in diameter, as shown in Figure 4.2.



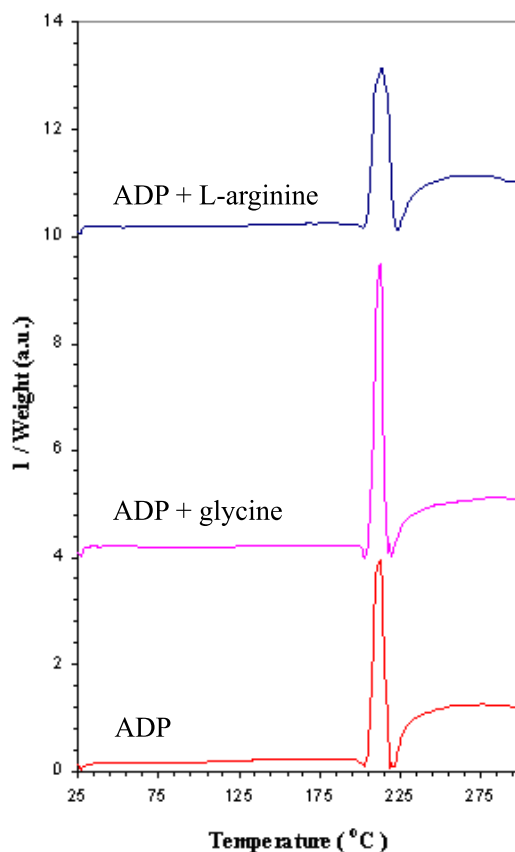
**Figure 4.3** The 1 mole % L-arginine doped ADP crystal grown by SR method.

## 4.4 Characterization

### 4.4.1 Thermal properties

Thermal analysis was employed to find out the weight and energy changes in the samples with respect to the temperature. In the present study, the thermal analysis was carried out on the crushed specimen of the SR method grown crystals by employing a Differential Scanning Calorimeter (Mettler Toledo DSC822) and Thermogravimetric Analyzer (Mettler Toledo TGA/SDTA 851) at 15°C/min heating rate in the nitrogen atmosphere.

Figure 4.4 shows the DSC spectra for the pure and doped ADP crystals grown by the SR method. The DSC curve shows a peak at 210.8°C for the pure ADP, 210.1°C for the glycine doped ADP and 212.3°C for the L-arginine doped ADP crystals. Figure 4.5 illustrates the TG curves for the pure and doped ADP crystals grown by the SR method. The TG curves of all samples indicate that they are stable up to 200°C.

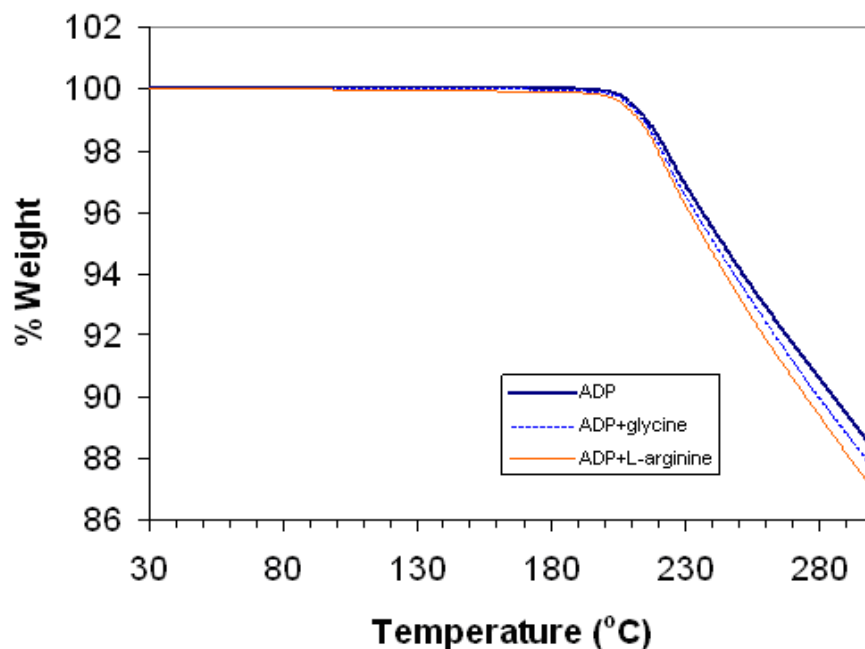


**Figure 4.4** Differential Scanning Calorimetry (DSC) data of the pure ADP, 1 mole % glycine and 1 mole % L-arginine doped ADP crystals grown by the SR method.

#### 4.4.2 X-ray diffraction analysis

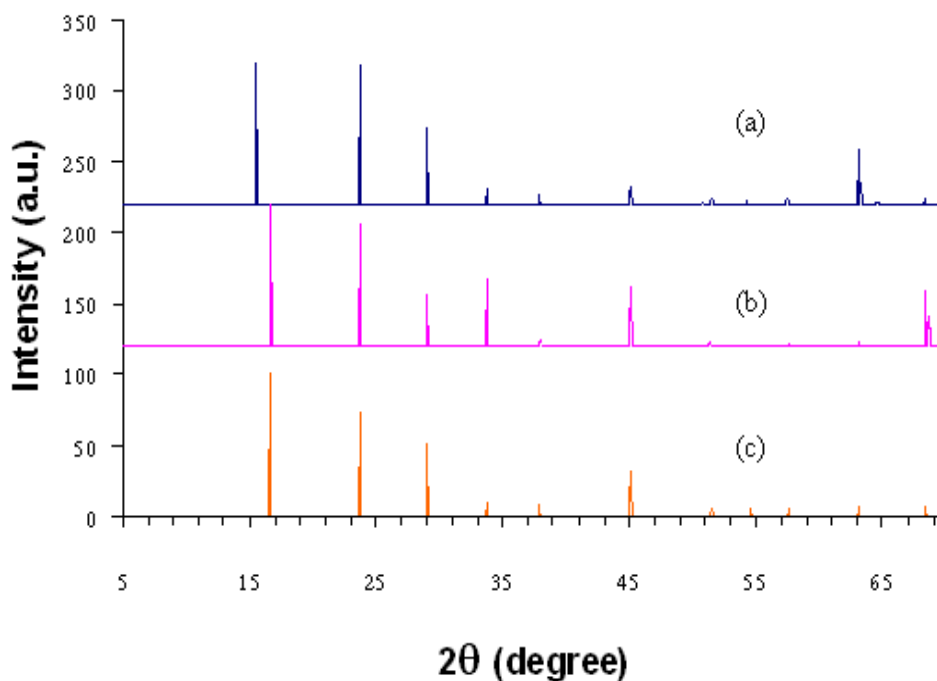
ADP belongs to scalenohedral class of tetragonal crystal system. Its unit cell parameters are  $a = b = 7.510 \text{ \AA}$  and  $c = 7.564 \text{ \AA}$  (Wyckoff, 1960). Powder X-ray diffraction analysis has been carried out using D5005 X-ray diffractometer (Bruker AXS) with  $\text{CuK}_\alpha$  ( $\lambda = 1.5418 \text{ \AA}$ ). The sample was scanned over 10-70 degrees at the rate of 1 degree/min.

Figure 4.6 shows the X-ray powder diffractogram of the ADP crystals. The powder X-ray diffraction studies of the pure and doped ADP crystals grown by both conventional and SR methods confirmed the tetragonal structure of the grown



**Figure 4.5** Thermogravimetric Analysis (TGA) data of the pure ADP, 1 mole % glycine and 1 mole % L-arginine doped ADP crystals grown by the SR method.

crystals. Results were compared with the JCPDS database where the prominent peaks of the reported values coincided with the investigated patterns. The pure ADP crystal has the tetramolecular unit cell, having the unit cell parameters  $a = b = 7.510 \text{ \AA}$  and  $c = 7.563 \text{ \AA}$ , while the 1 mole % glycine doped ADP crystal has the unit cell parameters  $a = b = 7.511 \text{ \AA}$  and  $c = 7.548 \text{ \AA}$ . The 1 mole % L-arginine doped ADP crystal has the unit cell parameters  $a = b = 7.539 \text{ \AA}$  and  $c = 7.538 \text{ \AA}$ . The crystals were identified by comparing the interplanar spacing and intensities of the XRD pattern with the JCPDS data of ADP crystals. The slight shift in the 2 values observed in the doped crystals suggests that their structure was slightly disturbed compared to that of the pure ADP crystals.

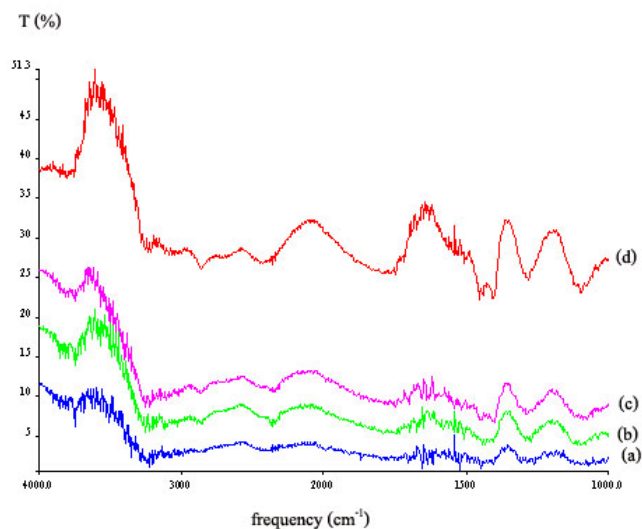


**Figure 4.6** X-ray powder diffractogram of the pure ADP (a), 1 mole % glycine doped ADP (b) and 1 mole % L-Arginine doped ADP (c) crystals grown by the SR method.

#### 4.4.3 FTIR studies

The Fourier Transform Infrared investigations were carried out on the powdered samples of the pure and doped ADP crystals. The spectrum was observed from SPECTRUM GX (Perkin Elmer) FTIR spectrophotometer in the regions 1000 - 4000  $\text{cm}^{-1}$  using a KBr pellet. The FTIR spectrum of the ADP crystal grown by the conventional method is shown in Figures 4.7 - 4.8 and that grown by the SR method in Figure 4.9. The group frequency region was located between 1300 - 400  $\text{cm}^{-1}$ . The characteristic vibrational frequencies of the pure and doped ADP crystals are very similar. The frequency range 1540 - 2500  $\text{cm}^{-1}$  contains triple bond frequencies which appear from 2000 to 2500  $\text{cm}^{-1}$  and double bond frequencies from 1540 to 2000  $\text{cm}^{-1}$ . The -NH group hydrogen stretching frequency at 3500 - 3000  $\text{cm}^{-1}$  is slightly broadened in the presence of high concentrations

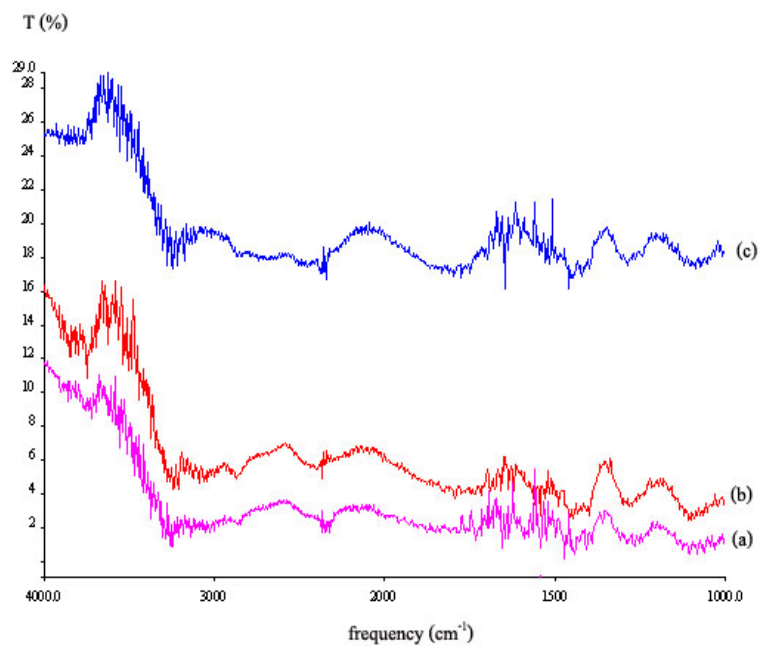
of dopant, indicating some type of interaction between the dopant and -NH group of the ADP which modifies the transparency of the crystal in that region.



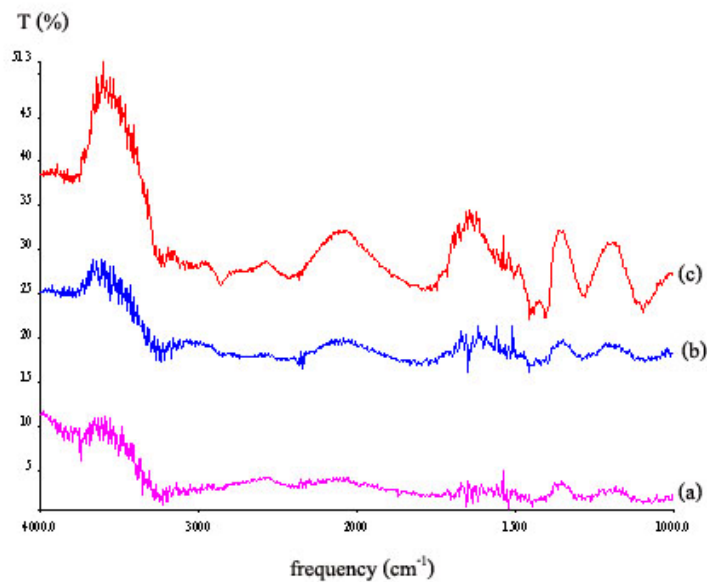
**Figure 4.7** FTIR spectra of the pure ADP (a) and ADP crystals doped with 3 mole % (b), 2 mole % (c) and 1 mole % (d) glycine grown by the conventional method.

#### 4.4.4 Optical property studies

Optical transmission spectra were recorded for the grown crystals by using a HITACHI U-1800 UV-Vis spectrometer. The recorded transmittance spectra of the pure and doped ADP crystals in the wavelength range 200 - 1200 nm are shown in Figures 4.10 - 4.11. The crystals have sufficient transmission in the entire visible and near infrared region. The optical transmission analysis revealed that the pure and doped ADP crystals have very low percentage of absorption in the entire visible region, which is a very essential property for NLO crystals.

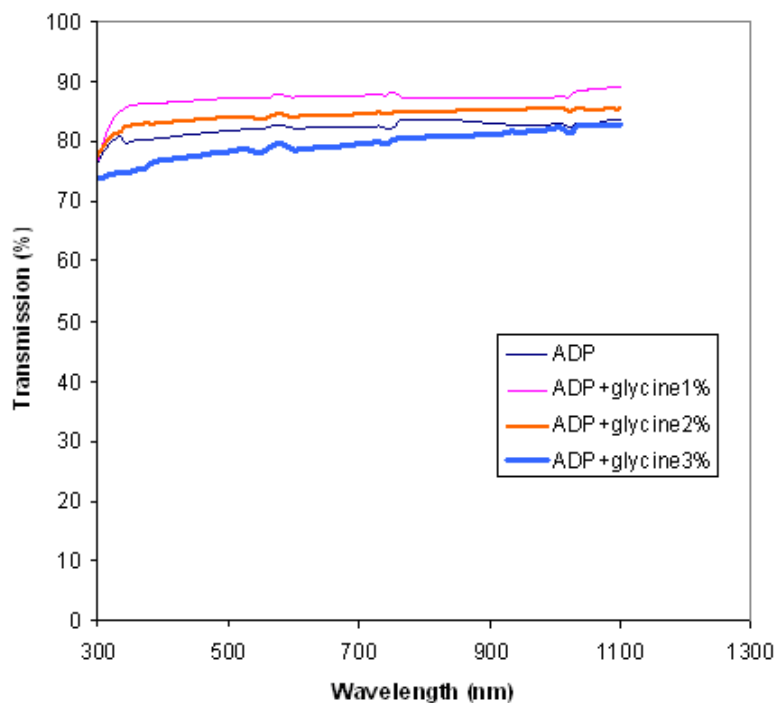


**Figure 4.8** FTIR spectra of the ADP crystals doped with 3 mole % (a), 2 mole % (b) and 1 mole % (c) L-arginine grown by the conventional method.



**Figure 4.9** FTIR spectra of the pure ADP (a), 1 mole % L-arginine (b) and 1 mole % glycine (c) doped ADP crystals grown by the SR method.



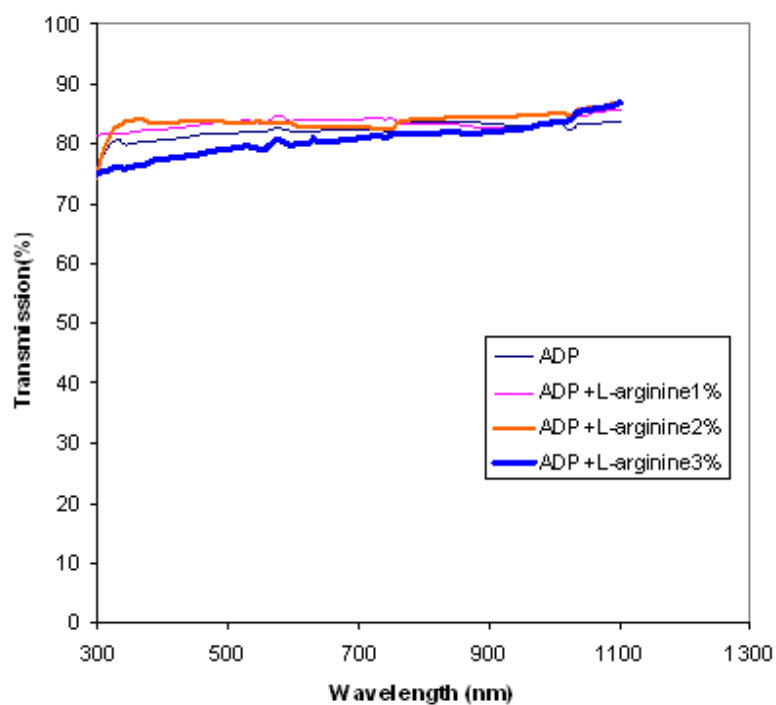


**Figure 4.10** UV-visible spectrum of the pure and glycine doped ADP crystals.

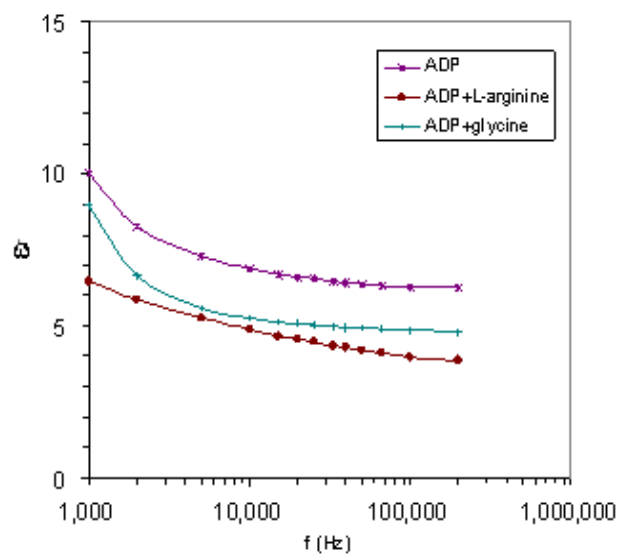
#### 4.4.5 Dielectric properties

Dielectric properties are correlated with electro-optic properties of the crystals; particularly when they are nonconducting materials. Permittivity characterization may yield some useful initial information. Microelectronics industry needs new low dielectric constant materials as an interlayer dielectric (Hatton et al., 2006). Some substances when doped to ADP may yield ADP with low dielectric constant (Meena and Mahadevan, 2008). In the present work, glycine and L-arginine were used as the dopant to reduce the dielectric constant of ADP. The dielectric properties of the pure and doped ADP crystals grown by both conventional and SR techniques were characterized.

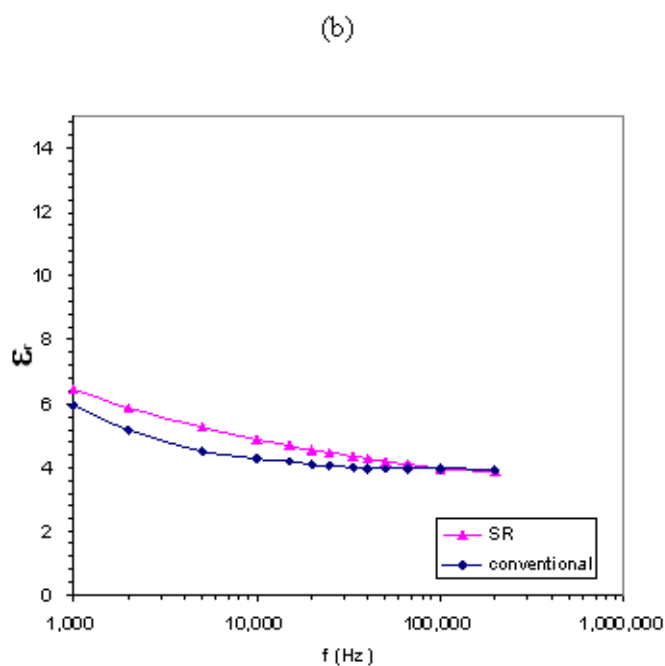
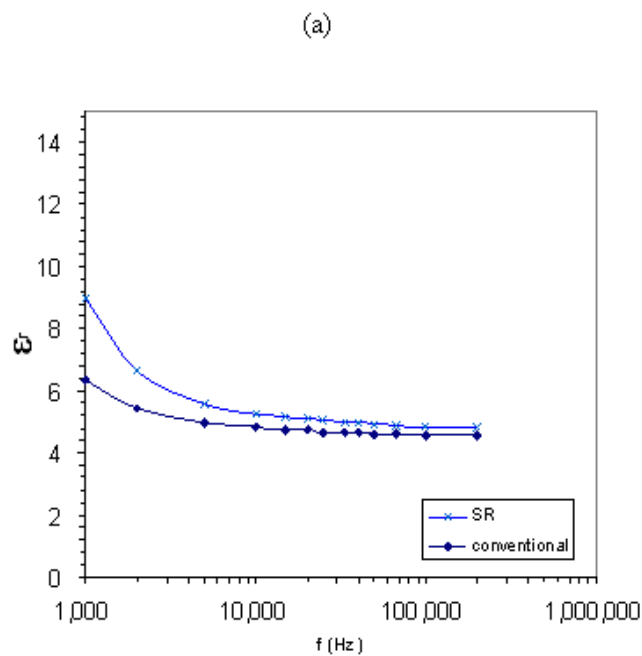
Samples were cut to a proper thickness and polished. Each sample was electroded on both sides with high purity silver paste so that it behaved like a



**Figure 4.11** UV-visible spectrum of the pure and L-arginine doped ADP crystals.



**Figure 4.12** Frequency dependence of the dielectric constant at 50°C of the pure, 1 mole % glycine doped ADP and 1 mole % L-arginine doped ADP crystals grown by the SR method.



**Figure 4.13** Frequency dependence of the dielectric constant at 50°C of the 1 mole % glycine doped ADP (a) and 1 mole % L-arginine doped ADP crystals (b).

parallel plate capacitor. Multi-frequency LCR meter (LCR-800 SERIES, Good Will Instrument) was employed to measure the capacitance ( $C$ ) and dielectric loss tangent ( $\tan\delta$ ) of the samples. The dielectric constant was calculated from  $C$  using

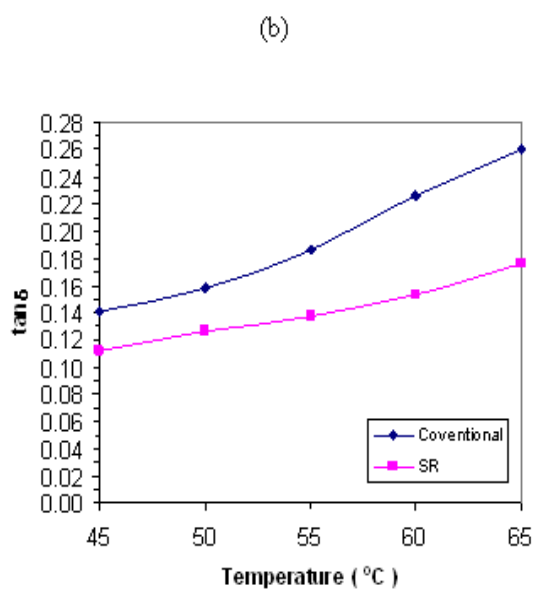
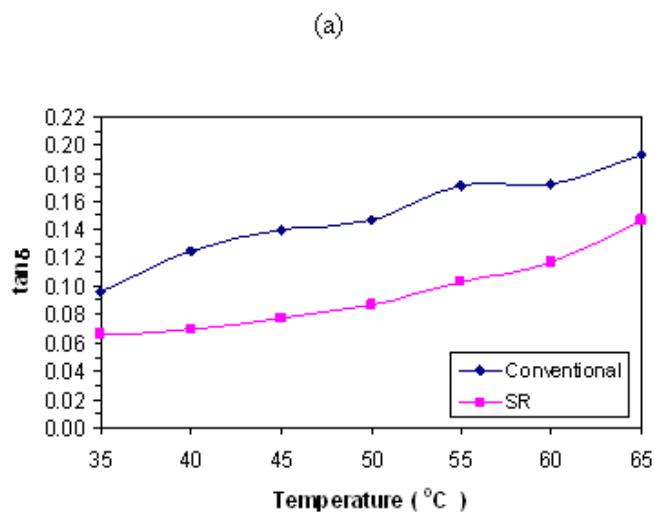
the relations :  $\varepsilon_r = Cd/A\varepsilon_0$  where  $d$  is the thickness of the sample,  $A$  is the area of the face in contact with the electrode and  $\varepsilon_0$  is the permittivity of free space ( $8.854 \times 10^{-12} \text{F/m}$ ).

The plot in Figures 4.12 - 4.13 shows the dielectric constant with different frequencies for the grown crystals. Decrease of the dielectric constant due to the L-arginine and glycine addition indicates the possibility of making ADP crystals with low  $\varepsilon_r$  values. The doped ADP crystals grown by SR method have the dielectric constant greater than the doped ADP crystals grown by the conventional method.

The plot in Figure 4.14 shows the dielectric loss tangent ( $\tan\delta$ ) of the doped ADP crystals grown by the conventional and SR methods at 10 kHz. Low dielectric loss at high frequencies indicates that the specimen crystal contains very low density of defects (Kushwaha et al., 2008). The dielectric loss of the doped ADP crystals grown by the SR method is lower than the dielectric loss of the doped ADP crystals grown by the conventional method. The good dielectric properties obtained here indicate that the ADP crystals grown by the SR method may be useful for variety of NLO applications.

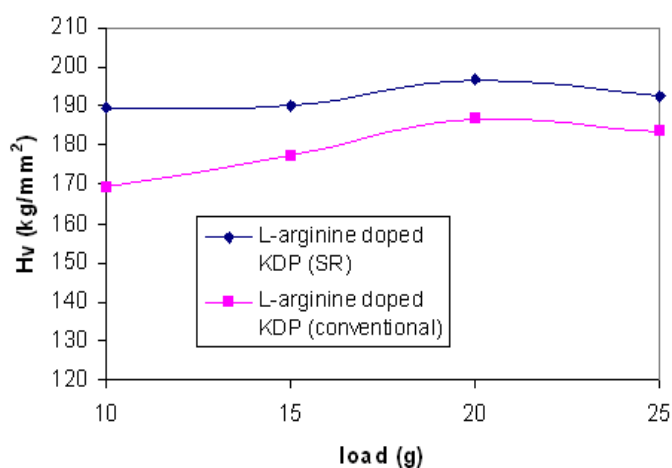
#### 4.4.6 Microhardness testing

The hardness of a material is a measure of its resistance to plastic deformation. Microhardness studies were carried out using MHT-10 Microhardness Tester (Anton-Paar) on the (001) plane of both the conventional and SR method grown crystals. Load of different magnitudes was applied. The indentation time was fixed as 10 s for each trial. The Vickers microhardness number ( $H_v$ ) was calculated using the relation  $H_v = 1.8544P/d^2$  ( $\text{kg/mm}^2$ ), where  $P$  is the indenter load (kg) and  $d$  is the diagonal length of the impression (mm). The plots of Vickers hardness versus load for the conventional and SR methods grown doped ADP crystals are shown in

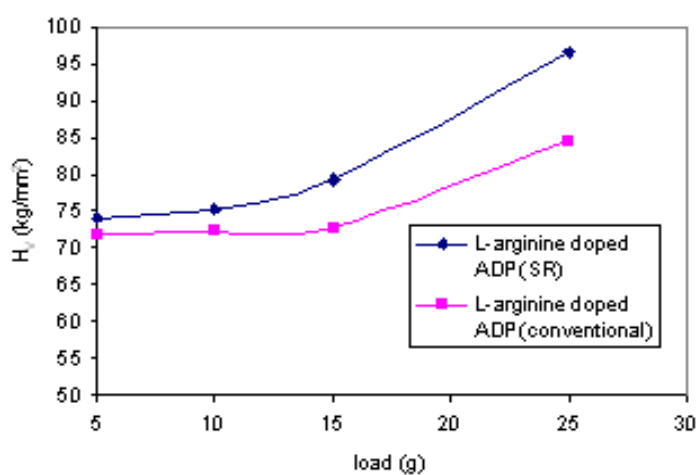


**Figure 4.14** Temperature dependence of the dielectric loss at 10 kHz of 1 mole % glycine doped ADP crystals (a) and 1 mole % L-arginine doped ADP crystals (b).

Figures 4.15 - 4.16. From the figures, it is seen that the hardness value for the SR grown crystals is higher than the hardness of the conventional method grown crystals. Larger hardness value for the SR method grown crystals indicates a greater stress required to form dislocation; thus confirming greater crystalline perfection. Similar results were reported in several crystals (Rajesh and Ramasamy, 2009; Balamurugan and Ramasamy, 2008; Senthil et al., 2008).



**Figure 4.15** Vickers microhardness of the 1 mole % L-arginine doped ADP crystals.



**Figure 4.16** Vickers microhardness of the 1 mole % glycine doped ADP crystals.

## 4.5 Conclusion

Single crystals of pure, L-arginine and glycine doped ADP have been grown by SR method. The crystal structure and functional groups were confirmed. Good dielectric properties were observed in the grown crystals. The DSC and TG investigations show that the grown crystals are stable up to 200°C. The optical

absorption analysis revealed that the pure and doped ADP crystals have very low percentage of absorption in the entire visible region, which is very essential for NLO crystals. Dielectric and microhardness measurements also indicate that the crystals grown by the SR method have good crystalline perfection and low density of defects.

## 4.6 References

- Balamurugan, S. and Ramasamy, P. (2008). Bulk growth of  $\langle 101 \rangle$  KDP crystal by Sankaranarayanan-Ramasamy method and its characterization. **Materials Chemistry and Physics**. 112(1): 4.
- Hatton, B.T., Landskron, K., Hunks, W.J., Bennett, M.R., Shukaris, D., Perovic, D.D. and Ozinna, G.A. (2006). Materials chemistry for low-k materials. **Materials Today**. 9(3): 22.
- Kushwaha, S.K. Vijayan, N. and Bhagavannarayana, G. (2008). Growth by SR method and characterization of bis(thiourea)zinc(II) chloride single crystals. **Materials Letters**. 62(24): 3933.
- Meena, M. and Mahadevan, C.K. (2008). Growth and electrical characterization of L-arginine added KDP and ADP single crystals. **Crystal Research and Technology**. 43(2):166.
- Rajesh, P. and Ramasamy, P. (2009). Growth of dl-malic acid-doped ammonium dihydrogen phosphate crystal and its characterization. **Journal of Crystal Growth**. 311(13): 3491.
- Sankaranarayanan, K. (2005). Growth of large size  $1\ 1\ 0$  benzophenone crystal

using uniaxially solution-crystallization method of Sankaranarayanan-Ramasamy (SR). **Journal of Crystal Growth**. 284(1-2): 203.

Sankaranarayanan, K. and Ramasamy, P. (2005). Unidirectional seeded single crystal growth from solution of benzophenone. **Journal of Crystal Growth**. 280(3-4): 467.

Sankaranarayanan, K. and Ramasamy, P. (2006). Growth of bezophenone crystals from solution: A novel approach with 100% solute-crystal conversion efficiency. **Crystal Research and Technology**. 41(3): 225.

Senthil Pandian, M., Balamurugan, N., Ganesh, V., Rajasekar, P.V., Kishan Rao, K. and Ramasamy, P. (2008). Growth of TGS single crystal by conventional and SR method and its analysis on the basis of mechanical, thermal, optical and etching studies. **Materials Letters**. 62(23): 3830.

Tukubo, H. and Makita, H. (1989). Refractometric studies of  $\text{NH}_4\text{H}_2\text{PO}_4$  and  $\text{KH}_2\text{PO}_4$  solution growth; experimental set-up and refractive index data. **Journal of Crystal Growth**. 94(2): 469.

Wyckoff, R. W. G. (1960). **Crystal structures**. (Vol.3). (2nd ed.). New York. Interscience.



# CHAPTER V

## GROWTH AND CHARACTERIZATION OF GLYCINE DOPED KDP SINGLE CRYSTALS

### 5.1 Abstract

Single crystals of glycine doped Potassium dihydrogen phosphate were grown by Sankaranarayanan-Ramasamy technique. Powder XRD, FTIR, DSC/TGA and microhardness studies of the samples were carried out. The optical transmission analysis indicates that the pure and doped KDP crystals have high percentage of transmission in the entire visible region. Vickers microhardness study shows higher mechanical stability in the doped KDP crystals grown by the SR method. Dielectric constants and dielectric loss of the samples grown by the conventional and SR method were measured. Their good dielectric properties show that the glycine doped KDP crystal grown by the SR method may be useful for various applications.

### 5.2 Introduction

Nonlinear optical materials are needed to realize applications in telecommunication, optoelectronics and laser technology. NLO crystals continue to be interesting materials both academically and industrially. NLO crystals with high conversion efficiencies for second harmonic generation are desirable in various applications. KDP is a dielectric material well known for its electro optical (ferroelectric at low temperature :  $T_c = 123$  K) and nonlinear optical properties

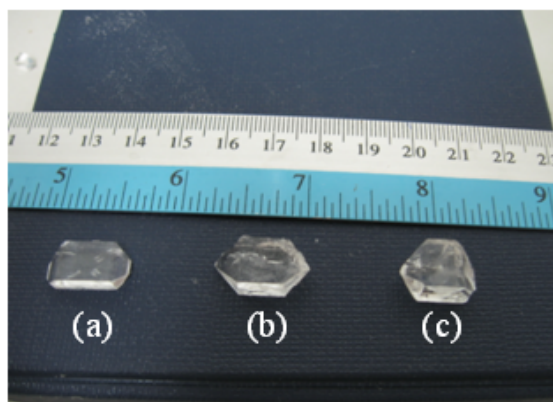
(DeYorea et al., 1996; Zaitseva et al., 1995). The excellent properties of KDP include transparency in a wide region of optical spectrum, resistance to damage by laser radiation and relatively high nonlinear efficiency. Therefore, it is commonly used in several applications such as laser fusion, electro-optical modulation and frequency conversion. In addition, KDP crystals exhibit pyroelectric effect. Many studies on the growth and properties of KDP crystals in the presence of impurities have been reported (Wang et al., 2006; Kannan et al., 2006; Podder et al., 2001; Claude et al., 2006). Since most of the amino acids exhibit NLO property, it is of interest to dope them in KDP (Parikh et al., 2007). With the aim of discovering new useful materials for academic and industrial use an attempt has been made to modify KDP crystals by adding some amino acids. KDP doped with amino acids like  $\alpha$ -alanine,  $\beta$ -alanine,  $\alpha$ -leucine,  $\alpha$ -histidine,  $\alpha$ -cystine and  $\alpha$ -valine were reported (Gunasekaran et al., 2004). Microelectronics industry needs new low dielectric constant materials as an interlayer dielectric (Meena and Mahadevan, 2008). Some substances when doped to KDP may yield KDP with low dielectric constant (Goma et al., 2006). In the present work, glycine was attempted as the dopant to reduce dielectric constant and modify KDP crystals. Kumar and Babu have shown that the second harmonic generation efficiency is found to be appreciably increased by addition of amino acid glycine as impurities in KDP crystals grown by conventional method (Kumar and Babu, 2008). A novel method called “ankaranarayanan-Ramasamy method” gives bulk unidirectional crystals with good quality from solution (Sankaranarayanan and Ramasamy, 2005). The SR solution growth technique is suitable to get unidirectional crystals from solution. The main advantages of SR solution growth technique are simple experimental set-up, unidirectional growth, high solute-solid conversion, minimum thermal stress on the crystal during growth and prevention of microbial growth

(Babu et al., 2006). In this chapter the growth by SR method and characterization of pure and glycine doped KDP crystals will be reported.

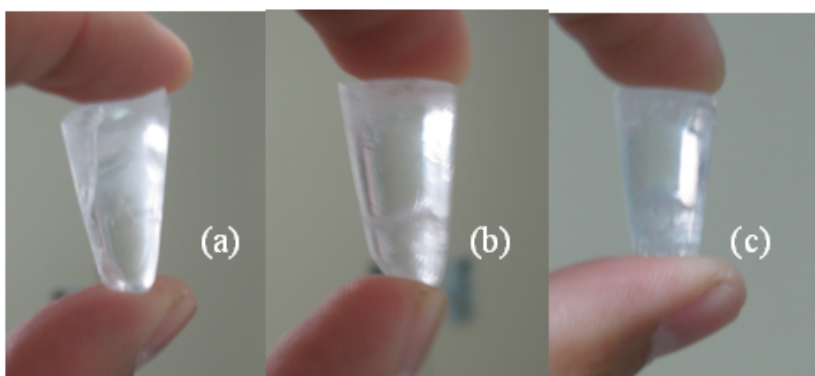
## 5.3 Experimental

### 5.3.1 Crystal growth

Analytical reagent grade samples of KDP and glycine along with de-ionized water were used for the growth of single crystals. The solution was in slightly undersaturation condition. The mixture was thoroughly stirred for 6 h for homogenization. The glycine doped KDP solution was filtered using No.1 whatman filter paper. Then the solution was poured in different beakers in the water-bath with constant temperature at 35°C. The product was purified by repeated recrystallization, typically thrice from de-ionized water. Seed crystals of pure and doped KDP were formed due to spontaneous nucleation. KDP crystals doped with glycine of different mole concentrations (1 mole %, 2 mole % and 3 mole %) have been crystallized by slow evaporation method. Seed crystals grown in 1 week are shown in Figure 5.1. Good quality seed crystals were taken for growing large size crystals by the SR method. The SR experimental set-up was shown in Figure 2.7 and two ring heaters are positioned in the top and bottom of ampoule and connected to temperature controller. The (001) plane of the seed crystal was selected for unidirectional crystal growth. A seed crystal was mounted at the bottom of the crucible. The temperature difference between the top and bottom heating coils was carefully maintained. After a time span of 30 days, good quality single crystals of doped ADP have been grown successfully with the size of  $\sim 30$  mm in length and  $\sim 10$  mm in diameter, as shown in Figure 5.2.



**Figure 5.1** KDP crystals grown from aqueous solutions containing different concentrations of glycine : (a) 1 mole %, (b) 2 mole % and (c) 3 mole %.



**Figure 5.2** Crystals grown by the SR method of 1 mole % (a), 2 mole % (b) and 3 mole % (c) glycine doped KDP.

### 5.3.2 Characterization

Powder X-ray diffraction analysis has been carried out using D5005 X-ray diffractometer (Bruker AXS) with  $\text{CuK}\alpha$  ( $\lambda = 1.5418\text{\AA}$ ). The sample was scanned over 10 - 70 degrees at rate of 1 degree/min. The FTIR spectrum was observed from SPECTRUM GX (Perkin Elmer) FTIR spectrophotometer in the regions 1000 - 4000  $\text{cm}^{-1}$  using a KBr pellet. Optical transmission spectra were recorded for the grown crystals by using HITACHI U-1800 UV-Vis spectrometer. Doped KDP samples were cut to a proper thickness and polished. Each sample was electroded on both sides with high purity silver paste so that it behaved like a

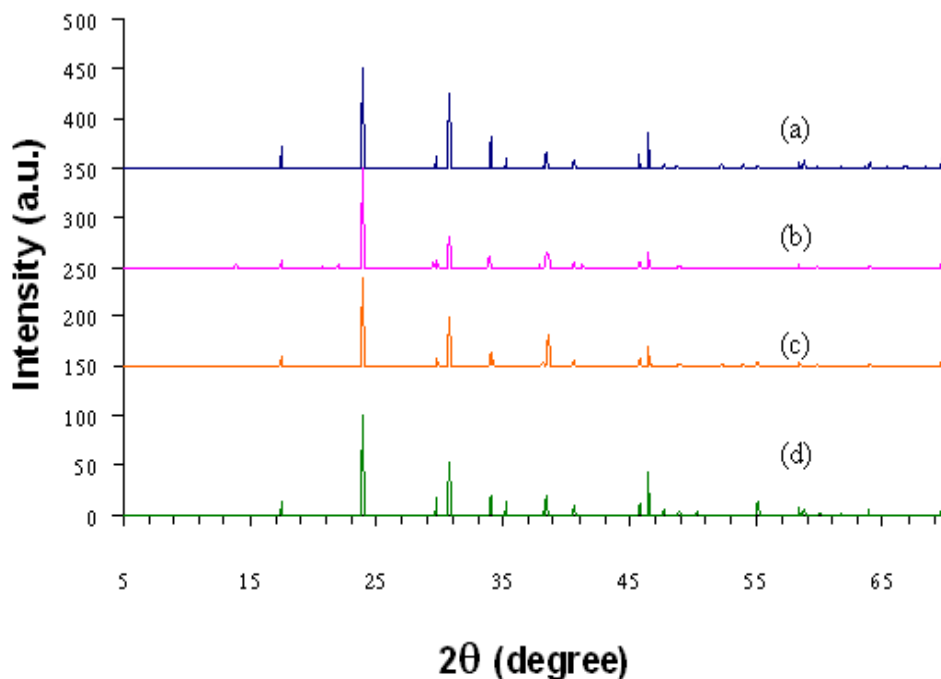
parallel plate capacitor. Multi-frequency LCR meter (LCR-800 SERIES, Good Will Instrument) was employed to measure the capacitance and dielectric loss tangent of the sample. The hardness of a material is a measure of its resistance to plastic deformation. Microhardness studies are carried out using (001) plane of both the conventional and SR method grown crystals (Anton-Paar, MHT-10 Microhardness Tester). Load of different magnitudes was applied. The indentation time was fixed as 10 s for each trial. Thermal analysis was used to find out the weight and energy change in the sample with respect to the temperature. In the present study, thermal analysis was carried out on the crushed specimen of the SR method grown crystals by employing a Differential Scanning Calorimeter (Mettler Toledo DSC822) and Thermogravimetric Analyzer (Mettler Toledo TGA/SDTA 851) at 15°C/min heating rate in the nitrogen atmosphere.

## 5.4 Results and discussions

### 5.4.1 X-ray diffraction analysis

Figure 5.3 shows the X-ray powder diffractogram of the pure and doped KDP crystals. Powder XRD studies of the doped KDP crystals grown by both the conventional and SR method confirmed the tetragonal structure of the grown crystals. Results were compared with the JCPDS database where the prominent peaks of the reported values coincided with the investigated patterns. The pure KDP crystal has the tetramolecular unit cell, having the unit cell parameters,  $a = b = 7.453 \text{ \AA}$  and  $c = 6.975 \text{ \AA}$  but those of the glycine doped KDP crystals were slightly larger in which  $a = b = 7.604 \text{ \AA}$  and  $c = 6.985 \text{ \AA}$ . The crystals were identified by comparing the interplanar spacing and intensities of the XRD pattern with the JCPDS data of the KDP crystals. The slight shift in the  $2\theta$  values of

the doped crystals suggests that their structure was slightly disturbed compared to the pure KDP crystals.

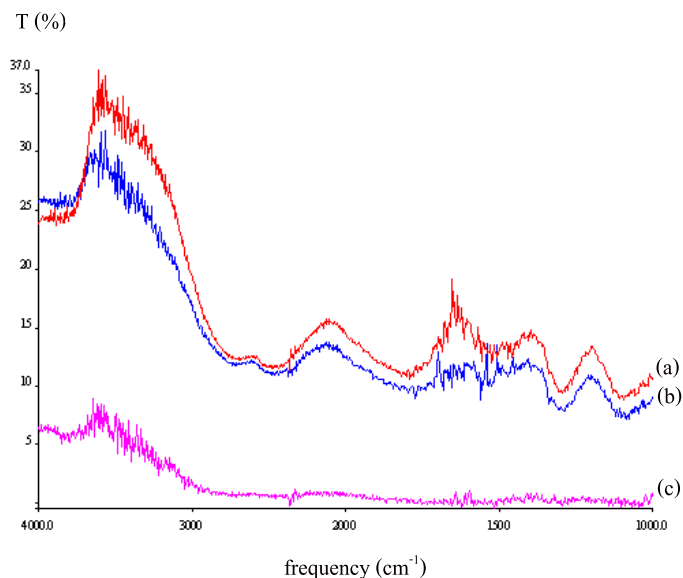


**Figure 5.3** X-ray powder diffractogram of pure KDP (a), 1 mole % (b), 2 mole % (c) and 3 mole % (d) glycine doped KDP crystals grown by the SR method.

#### 5.4.2 FTIR studies

The Fourier Transform Infrared investigations were carried out on the powdered samples of the doped KDP crystals. The FTIR spectrum of the glycine doped KDP crystals grown by the SR method is shown in Figure 5.4. The broad envelopes observed between 2300 and 3600  $\text{cm}^{-1}$  are mainly due to P-OH stretching of  $\text{H}_2\text{PO}_4$ , O-H stretching of COOH, N-H stretching and C-H stretching. The -NH group hydrogen stretching frequency at 3500 - 3000  $\text{cm}^{-1}$  is slightly broadened in the presence of high concentrations of dopant, indicating some type of interaction between the dopant and -NH group of KDP and modifies the transparency

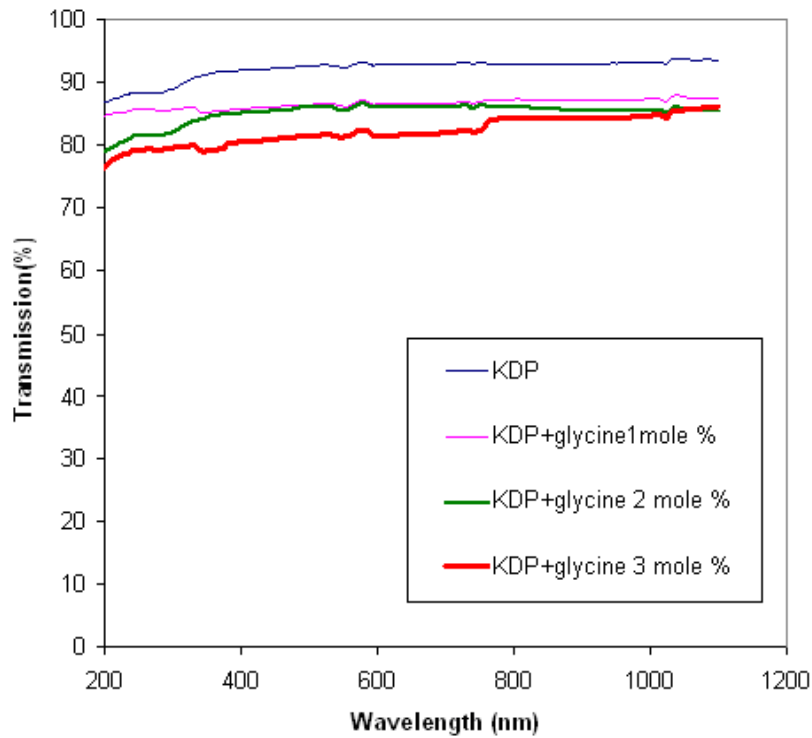
of the crystal in that region. The  $\text{C}=\text{NH}_4$  stretching and the  $\text{C}=\text{O}$  stretching are revealed by minor absorption peak at the frequency  $1750\text{ cm}^{-1}$ .



**Figure 5.4** FTIR spectra of SR method grown KDP crystals doped with 1 mole % (a), 2 mole % (b) and 3 mole % (c) of glycine.

### 5.4.3 Optical property studies

The recorded transmittance spectra of the pure and doped KDP crystals in the wavelength range 200 - 1200 nm are shown in Figure 5.5. The crystals have sufficient transmission in the entire visible and near Infrared region. The optical transmission analysis revealed that the doped KDP crystals have very high percentage of transmission in the entire visible region, which is a very essential property for NLO crystals.



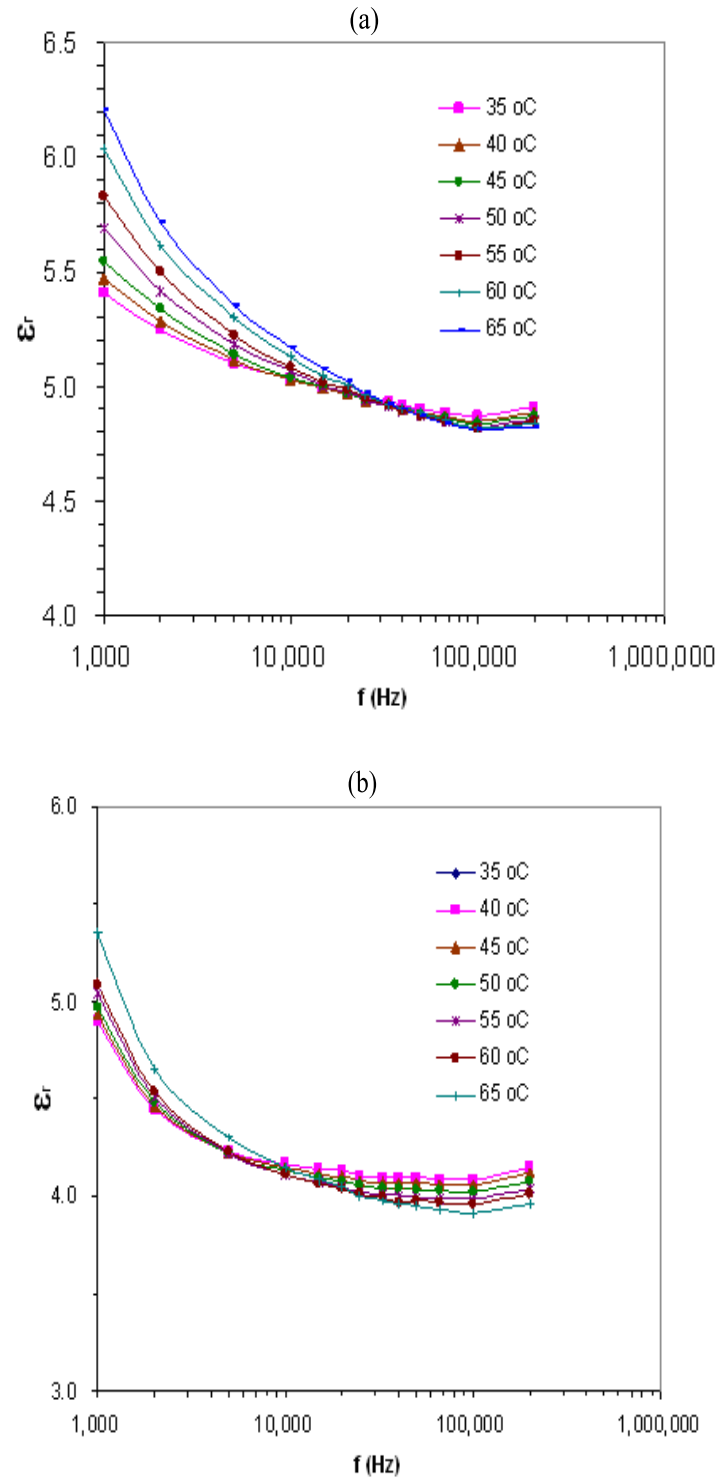
**Figure 5.5** UV-visible spectrum of the pure and glycine doped KDP crystals grown by the SR method.

#### 5.4.4 Dielectric constant

Dielectric properties are correlated with electro-optic properties of the crystals particularly when they are nonconducting materials. Permittivity characterization may yield some useful initial information. The doped KDP crystals grown by both the conventional and SR methods were characterized by dielectric constant studies. The dielectric constant was calculated from  $C$  using the relation :  $\epsilon_r = Cd/A\epsilon_0$  where  $d$  is the thickness of the sample,  $A$  is the area of the face in contact with the electrode and  $\epsilon_0$  is the permittivity of free space ( $8.854 \times 10^{-12} \text{F/m}$ ).

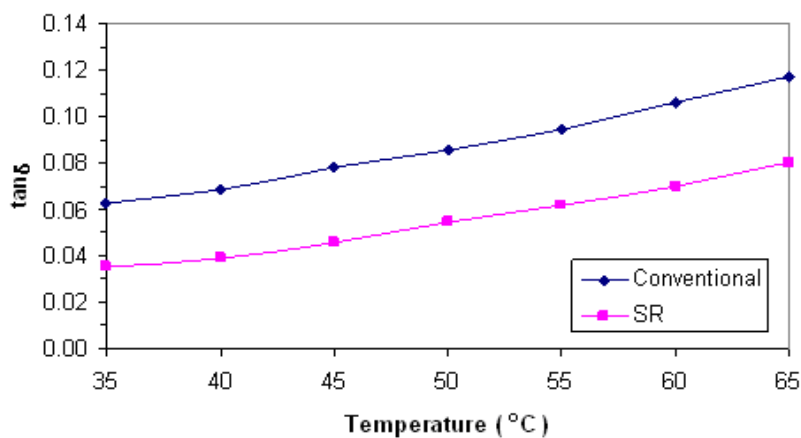
The plot in Figure 5.6 shows the dielectric constant with different frequencies for the grown crystals. Dielectric constant is found to increase with tem-





**Figure 5.6** Frequency dependence of dielectric constant at different temperatures of the 1 mole % (a) and 3 mole % (b) glycine doped KDP crystals grown by the SR method.

perature at low frequencies (1 - 10 kHz) but decrease with temperature at high frequencies (more than 10 kHz) and  $\varepsilon_r$  values of the glycine doped KDP crystals grown by the SR method were less than those of the pure KDP crystals. In the present study, amino acid glycine was attempted as the dopant to reduce dielectric values of KDP. Decrease of the  $\varepsilon_r$  values due to the glycine addition indicates the possibility of making KDP crystals the low  $\varepsilon_r$  value dielectrics.

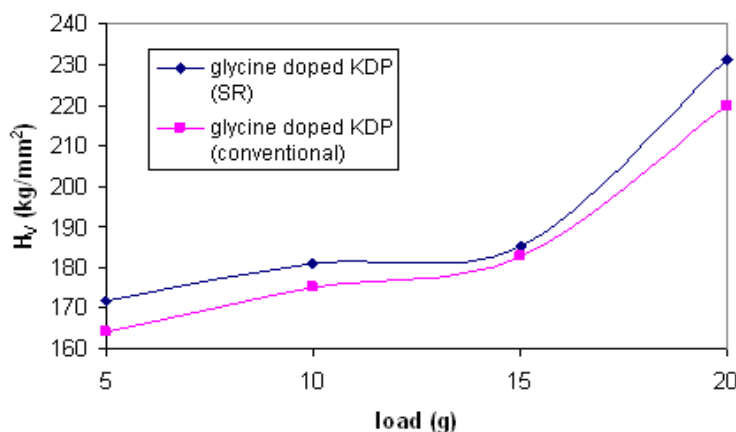


**Figure 5.7** Temperature dependence of dielectric loss at 10 kHz of the 1 mole % glycine doped KDP crystals.

The plot in Figure 5.7 shows the loss factor for the 1 mole % glycine doped KDP crystals grown by the conventional and SR methods at different frequencies. Low dielectric loss at high frequencies indicates that the specimen crystal contains very low density of defects. The loss factor of the doped KDP crystals grown by the SR method is lower than the loss factor of the doped KDP crystals grown by the conventional method. The good dielectric properties indicate that the KDP crystal grown by the SR method may be useful for variety of NLO applications.

### 5.4.5 Microhardness testing

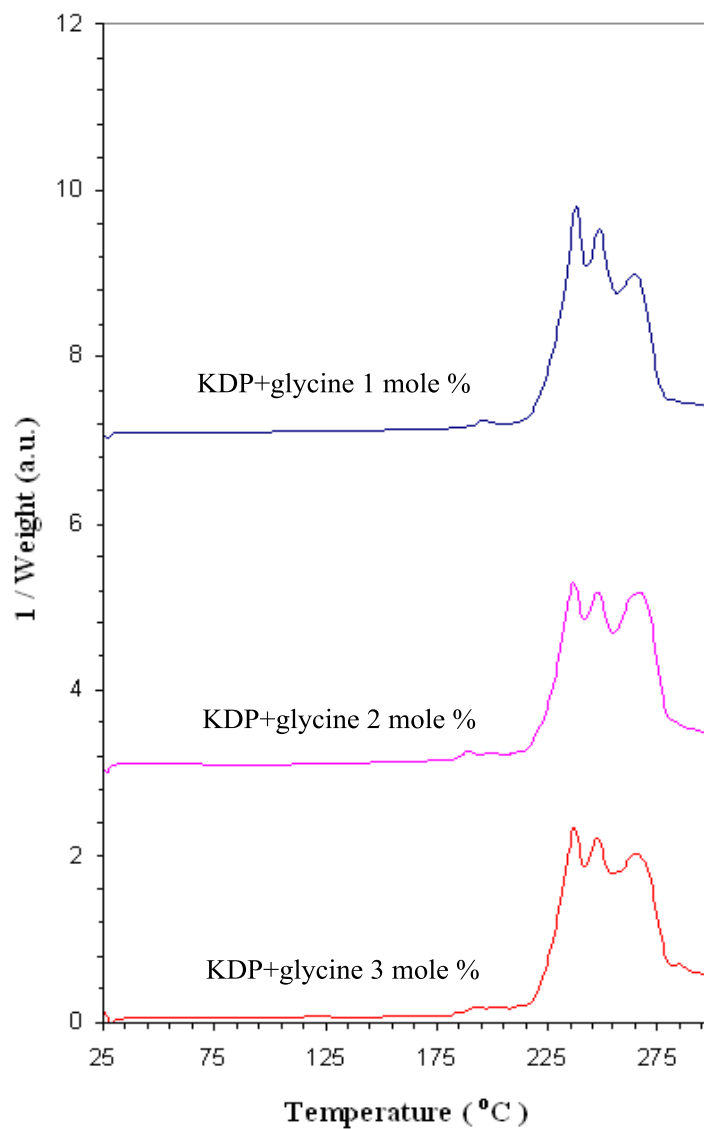
The Vickers microhardness number was calculated using relation :  $H_v = 1.8544P/d^2$  ( $\text{kg}/\text{mm}^2$ ) where  $P$  is the indenter load (kg) and  $d$  is the diagonal length of the impression (mm). The plot of Vickers hardness versus load for the conventional and SR methods grown doped KDP crystals is shown in Figure 5.8. From the graph, it is seen that the hardness value for the SR grown crystal is higher than the hardness of the conventional method grown crystal. Larger hardness value for the SR method grown crystal indicates greater stress required to form dislocation thus confirming greater crystalline perfection.



**Figure 5.8** microhardness of the 1 mole % glycine doped KDP crystals.

### 5.4.6 Thermal studies

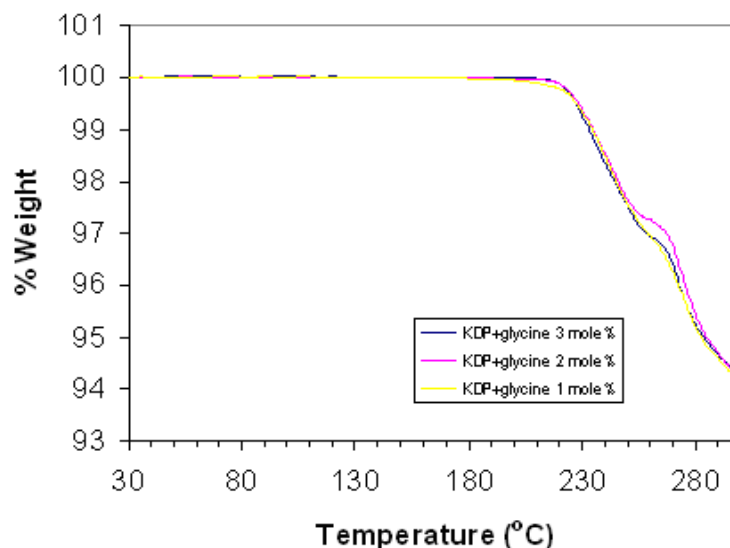
Figure 5.9 shows the DSC spectra for the glycine doped KDP crystals grown by the SR method. It is found that there are endothermic peaks at  $236^\circ\text{C}$ ,  $248^\circ\text{C}$  and  $266^\circ\text{C}$ . Figure 5.10 illustrates the TG curves for the doped KDP crystals grown by the SR method. The TG curves of the samples indicate that they are stable up to  $200^\circ\text{C}$ .



**Figure 5.9** Differential Scanning Calorimetry data of the glycine doped KDP crystals grown by the SR method.

## 5.5 Conclusion

Single crystals of glycine doped KDP have been grown by SR method. The crystal structure and functional groups were confirmed. The DSC and TG investigations show that the grown crystals are stable up to 200°C. The optical transmission analysis revealed that glycine doped KDP crystals have very high



**Figure 5.10** Thermogravimetric Analysis data of the glycine doped KDP crystals grown by the SR method.

percentage of transmission in the entire visible region, coupled with good dielectric properties, which is very essential for NLO crystals. Dielectric and microhardness measurements also indicate that the crystals grown by the SR method have good crystalline perfection and low density of defects.

## 5.6 References

Babu, R.R., Sethuraman, K., Gopalakrishnan, R. and Ramasamy, P. (2006).

Growth of L-lysine monohydrochloride dihydrate bulk single crystal by Sankaranarayanan-Ramasamy (SR) method. **Journal of Crystal Growth.** 297(2): 356.

Claude, A., Vaithianathan, V., Ganesh, R.B., Sathyalakshmi, R and Ramasamy, P. (2006). Crystal growth of novel bimetallic Nickel, Magnesium ( $\text{Ni}^{3+}$ ,  $\text{Mg}^{2+}$ ) Potassium dihydrogen phosphate by solution growth and their characterization. **Journal of Applied Sciences.** 6(3): 635.

- DeYorea, J.J. Rek, Z.U., Zaitseva, N.P. and Woods, B.W. (1996). Sources of optical distortion in rapidly grown crystals of  $\text{KH}_2\text{PO}_4$ . **Journal of Crystal Growth**. 166(1-4): 291.
- Goma, S., Padma, C.M. and Mahadevan, C.K. (2006). Dielectric parameters of KDP single crystals added with urea. **Materials Letters**. 60(29-30): 3701.
- Gunasekaran, S., Ponnusamy, S. and Rajasekaran, R. (2004). Growth and characterisation of potassiumdihydrogen phosphate (KDP) crystal doped with ammo acid. **Indian Journal of Physics**. 78(7): 553.
- Kannan, V., Ganesh, R.B., Sathyalakshmi, R, Rajesh, N.P. and Ramasamy, P. (2006). Investigation of  $\text{La}^{3+}$  ions on growth and NLO properties of KDP single crystals. **Crystal Research and Technology**. 41(7): 678.
- Kumar, B.S. and Babu, K.R. (2008). Effect of L-arginine and glycine on the growth of KDP single crystals and their characterization. **Indian Journal Pure and Applied Physics**. 46: 123.
- Meena, M. and Mahadevan, C.K. (2008). Growth and electrical characterization of L-arginine added KDP and ADP single crystals. **Crystal Research and Technology**. 43(2): 166.
- Parikh, K.D., Dave, D.J., Parekh, B.B. and Joshi, M.J. (2007). Thermal, FT-IR and SHG efficiency studies of L-arginine doped KDP crystals. **Bulletin of Materials Science**. 3(2): 105.
- Podder, J., Ramalingom, S. and Kalkura, S.N. (2001). An investigation on the lattice distortions in urea and KCl doped KDP single crystals by X-ray diffraction studies. **Crystal Research and Technology**. 36(6): 549.

- Sankaranarayanan, K. and Ramasamy, P. (2005). Unidirectional seeded single crystal growth from solution of benzophenone. **Journal of Crystal Growth**. 280(3-4): 467.
- Wang, B., Fang, Ch., Wang, Sh., Sun, X., Li, Q.G.Y., Xu, X., Zhang, J., Liu, B. and Mou, X. (2006). The effect of  $\text{Sn}^{4+}$  ion on the growth habit and optical properties of KDP crystal. **Journal of Crystal Growth**. 297(2): 352.
- Zaitseva, N.P., Rashkovich, L.N. and Bogatyreva, S.V. (1995). Stability of  $\text{KH}_2\text{PO}_4$  and  $\text{K}(\text{H,D})_2\text{PO}_4$  solutions at fast crystal growth rates. **Journal of Crystal Growth**. 148(3): 276.

# CHAPTER VI

## GROWTH AND CHARACTERIZATION OF L-ARGININE DOPED KDP SINGLE CRYSTALS

### 6.1 Abstract

L-arginine doped Potassium dihydrogen orthophosphate single crystals were grown by Sankaranarayanan-Ramasamy technique. Powder XRD, FTIR, micro-hardness, thermal and dielectric properties studies of the samples were carried out. The optical transmission analysis indicates that the pure and doped KDP crystals have high percentage of transmission in the entire visible region. Their good dielectric and good mechanical properties show that L-arginine doped KDP crystals grown by SR technique may be useful for various applications.

### 6.2 Introduction

Potassium dihydrogen phosphate is very popular due to its applications in frequency converters and electro-optic switching. Optical quality KDP crystals can be grown by solution growth. This material offers high transmission throughout the visible spectrum and high laser damage threshold. KDP continues to be an interesting material both industrially and academically. Many studies on the growth and properties of KDP crystals in the presence of impurities have been reported (Wang et al., 2006; Kannan et al., 2006; Podder et al., 2001; Claude et al., 2006).



With the aim of discovering new useful materials for academic and industrial use, an attempt has been made to modify KDP crystals by adding some amino acids. KDP doped with amino acids like  $\alpha$ -alanine,  $\beta$ -alanine,  $\alpha$ -leucine,  $\alpha$ -histidine,  $\alpha$ -cystine and  $\alpha$ -valine were reported (Gunasekaran et al., 2004). Microelectronics industry needs replacement of dielectric materials in multilevel interconnect structures with new low dielectric constant materials. L-arginine was attempted as the dopant to reduce  $\epsilon_r$  value of KDP crystals. Decrease of  $\epsilon_r$  value due to L-arginine addition indicates the possibility of making KDP crystals the low  $\epsilon_r$  value dielectric (Meena and Mahadevan, 2008). In addition, the second harmonic generation efficiency of L-arginine doped KDP crystals grown by conventional solution method were found to be increasing with doping concentration of L-arginine (Parikh et al., 2007). A new method called “ankaranarayanan-Ramasamy method” or SR method gives bulk unidirectional crystals with good quality from solution (Sankaranarayanan and Ramasamy, 2005; Babu et al., 2006).

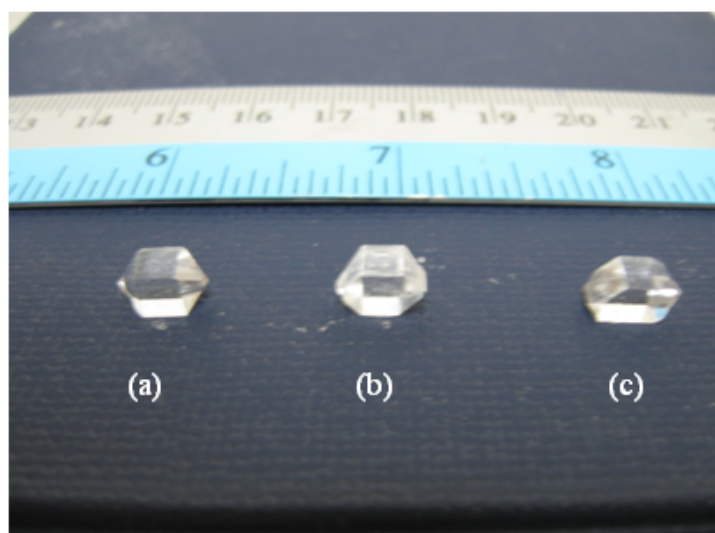
In this chapter the growth by SR method and characterization of L-arginine doped KDP crystals will be reported.

## **6.3 Experimental**

### **6.3.1 Crystal growth by the conventional slow evaporation technique**

Analytical reagent grade samples of KDP and L-arginine along with deionized water were used for the growth of single crystals. The solution was in slightly undersaturation condition. The solution was constantly stirred for 6 h using magnetic stirrer. L-arginine doped KDP solution was filtered using No.1 whatman filter paper. Then the solution was poured in a different beaker in

the water-bath with constant temperature at 35°C. The product was purified by repeated recrystallization, typically thrice from de-ionized water. KDP crystals doped with L-arginine of different mole concentrations (1 mole %, 2 mole % and 3 mole %) have been crystallized by the low temperature solution growth technique. Seed crystals of the pure and doped KDP were formed due to spontaneous nucleation. Seed crystals grown in 1 week are shown in Figure 6.1. Good quality seed crystals were taken for growing large size crystals by the SR method.

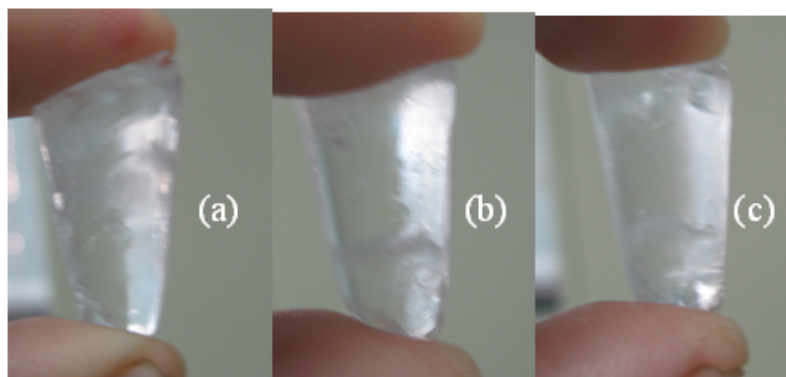


**Figure 6.1** KDP crystals grown from aqueous solutions containing different concentrations of L-arginine : (a) 1 mole % , (b) 2 mole % and (c) 3 mole %.

### 6.3.2 Crystal growth of the doped KDP by the SR method

We have employed the SR method to grow L-arginine doped KDP single crystals. The main advantages of the SR solution growth method are simple experimental set-up, unidirectional growth, high solute-solid conversion, minimum thermal stress on the crystal during growth and prevention of microbial growth. Growth condition of this method depends on the temperatures of heating coils. The c-axis of the seed crystal was selected for unidirectional crystal growth. A

seed crystal obtained in the previous section was mounted at the bottom of the ampoule. The temperature difference between the top and bottom heating coils was carefully maintained. After a time span of 30 days, good quality single crystals of the doped KDP have been grown successfully with size  $\sim 50$  mm length and  $\sim 20$  mm dia., as shown in Figure 6.2.



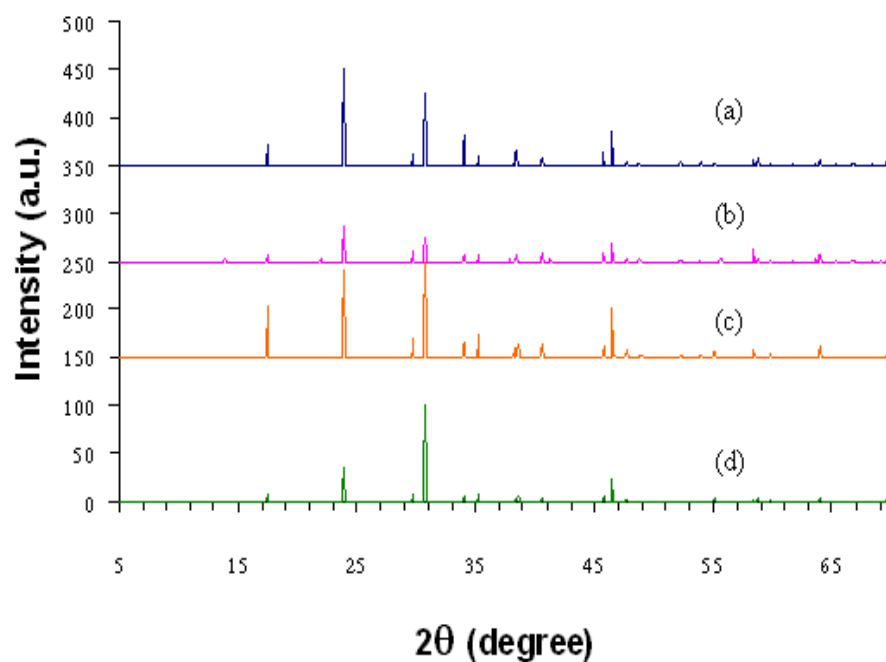
**Figure 6.2** The crystals grown by the SR method of 1 mol % (a), 2 mole % (b) and 3 mole % (c) L-arginine doped KDP.

## 6.4 Characterization

### 6.4.1 X-ray diffraction analysis

Powder X-ray diffraction analysis has been carried out using D5005 X-ray diffractometer (Bruker AXS) with  $\text{CuK}\alpha$  ( $\lambda = 1.5418\text{\AA}$ ). The sample was scanned over 10 - 70 degrees at the rate of 1 degree/min. Virtually monochromatic radiation is obtained by reflecting X-rays from crystal planes. The relationship between the wavelength of X-ray beam, the angle of diffraction  $\theta$ , and the distance between each set of planes of the crystal lattice,  $d_{hkl}$ , is given by Bragg condition  $2d_{hkl} \sin \theta = n\lambda$  where  $n$  represents the order of diffraction. Figure 6.3 shows the X-ray powder diffractogram of the doped KDP crystal. Powder X-ray diffraction studies of the doped KDP crystals grown by both the conventional and SR methods confirmed

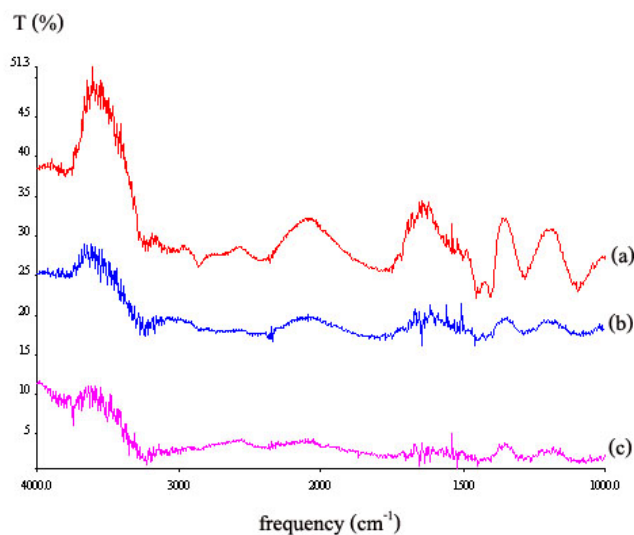
the tetragonal structure of the grown crystals. Results were compared with the JCPDS database where the prominent peaks of the reported values coincided with the investigated patterns. The pure KDP crystal has the tetramolecular unit cell, having the unit cell parameters,  $a = b = 7.453 \text{ \AA}$  and  $c = 6.975 \text{ \AA}$  but the 1 mole % L-arginine doped KDP crystal has the unit cell parameters,  $a = b = 7.423 \text{ \AA}$  and  $c = 6.956 \text{ \AA}$ . The crystals were identified by comparing the interplanar spacing and intensities of the XRD pattern with the JCPDS data of KDP crystals. The slight shift in the  $2\theta$  values of the doped crystals suggests that their structure was slightly disturbed comparing to the pure KDP crystals.



**Figure 6.3** X-ray powder diffractogram of the pure KDP (a), 1 mole % (b), 2 mole % (c) and 3 mole % (d) L-Arginine doped KDP crystals grown by the SR method.

### 6.4.2 FTIR studies

The infrared spectroscopy is mainly concerned with the absorption of vibrational energy by a molecule, ion or radical from a continuum or with the study of emission of infrared radiation by species of excited states. It is one of the influential tools for recognition of organic, inorganic, polymeric, crystalline and coordination compounds. The Fourier Transform Infrared investigations were carried out on the powdered samples of the doped KDP crystals. Fourier transform spectroscopy is a simple mathematical technique to resolve a complex wave into its frequency components. Fourier Transform Infrared (FTIR) has made the mid IR region more useful. The spectrum was observed from SPECTRUM GX (Perkin Elmer) FTIR spectrophotometer in the regions  $1000\text{-}4000\text{ cm}^{-1}$  using a KBr pellet.



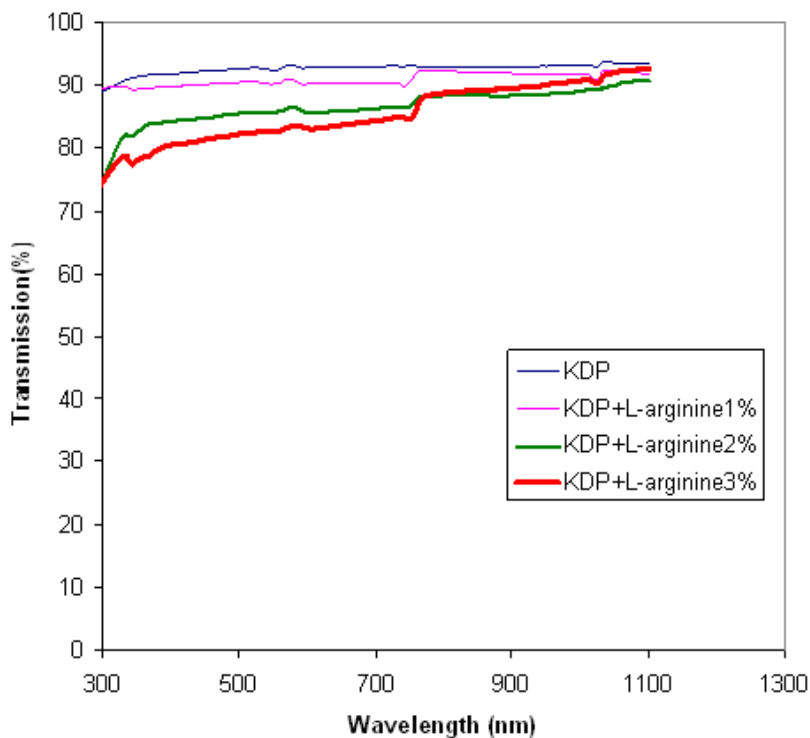
**Figure 6.4** FTIR spectra of SR method grown KDP crystals doped with 1 mole % (a), 2 mole % (b) and 3 mole % (c) of L-arginine.

The FTIR spectrum of the doped KDP crystal grown by the SR method is shown in Figure 6.4. The broad envelopes observed between  $2300\text{ and }3600\text{ cm}^{-1}$  are mainly due to P-OH stretching of  $\text{H}_2\text{PO}_4$ , O-H stretching of  $\text{COOH}^-$ ,

C-H stretching of CH and CH<sub>2</sub>, N-H stretching of NH<sub>3</sub><sup>+</sup>. In the spectra of amino acid L-arginine doped crystals, some bands of H<sub>2</sub>PO<sub>4</sub><sup>-</sup> overlap with amino acid vibrations. Hence few bands of H<sub>2</sub>PO<sub>4</sub><sup>-</sup> become broader and some of the frequencies are slightly shifted. The broadness is generally considered to be due to hydrogen bonding interaction of COOH<sup>-</sup>, NH<sub>3</sub><sup>+</sup> and H<sub>2</sub>PO<sub>4</sub><sup>-</sup> with adjacent molecule.

### 6.4.3 Optical property studies

A spectrophotometer is a device which detects the percentage transmittance of light of certain intensity and frequency range which is passed through the sample. Thus the instrument compares the intensity of the transmitted light with that of incident light. Optical transmission spectra were recorded for the grown crystals by using HITACHI U-1800 UV-Vis spectrometer.



**Figure 6.5** UV-visible spectrum of the pure and L-arginine doped KDP crystals.

The recorded transmittance spectra of pure and doped KDP crystals in the wavelength range 200 - 1200 nm are shown in Figure 6.5. The crystals have sufficient transmission in the entire visible and near Infrared region. The optical transmission analysis revealed that the L-arginine doped KDP crystals have very low percentage of absorption in the entire visible region, which is a very essential property for NLO crystals.

#### 6.4.4 Dielectric constant

Dielectric properties are correlated with electro-optic properties of the crystals particularly when they are nonconducting materials. Permittivity characterization may yield some useful initial information. Microelectronics industry needs new low dielectric constant materials as an interlayer dielectric. Some substances when doped to KDP may yield KDP with low dielectric constant. In the present work, L-arginine was attempted as the dopant to reduce dielectric constant of KDP. The doped KDP crystals grown by both the conventional and SR method were characterized by dielectric constant studies. Samples were cut to a proper thickness and polished. Each sample was electroded on both sides with high purity silver paste so that it behaved like a parallel plate capacitor. Multi-frequency LCR meter (LCR-800 SERIES, Good Will Instrument) was employed to measure the capacitance and dielectric loss tangent of the sample. The dielectric constant was calculated from  $C$  using the relation :  $\epsilon_r = Cd/A\epsilon_0$  where  $d$  is the thickness of the sample,  $A$  is the area of the face in contact with the electrode and  $\epsilon_0$  is the permittivity of free space ( $8.854 \times 10^{-12}$  F/m). The plot in Figure 6.6 shows the dielectric constant with different frequencies for the grown crystals. The doped KDP crystal grown by the SR method has the dielectric constant greater than the L-arginine doped KDP crystal grown by the conventional method at all measured

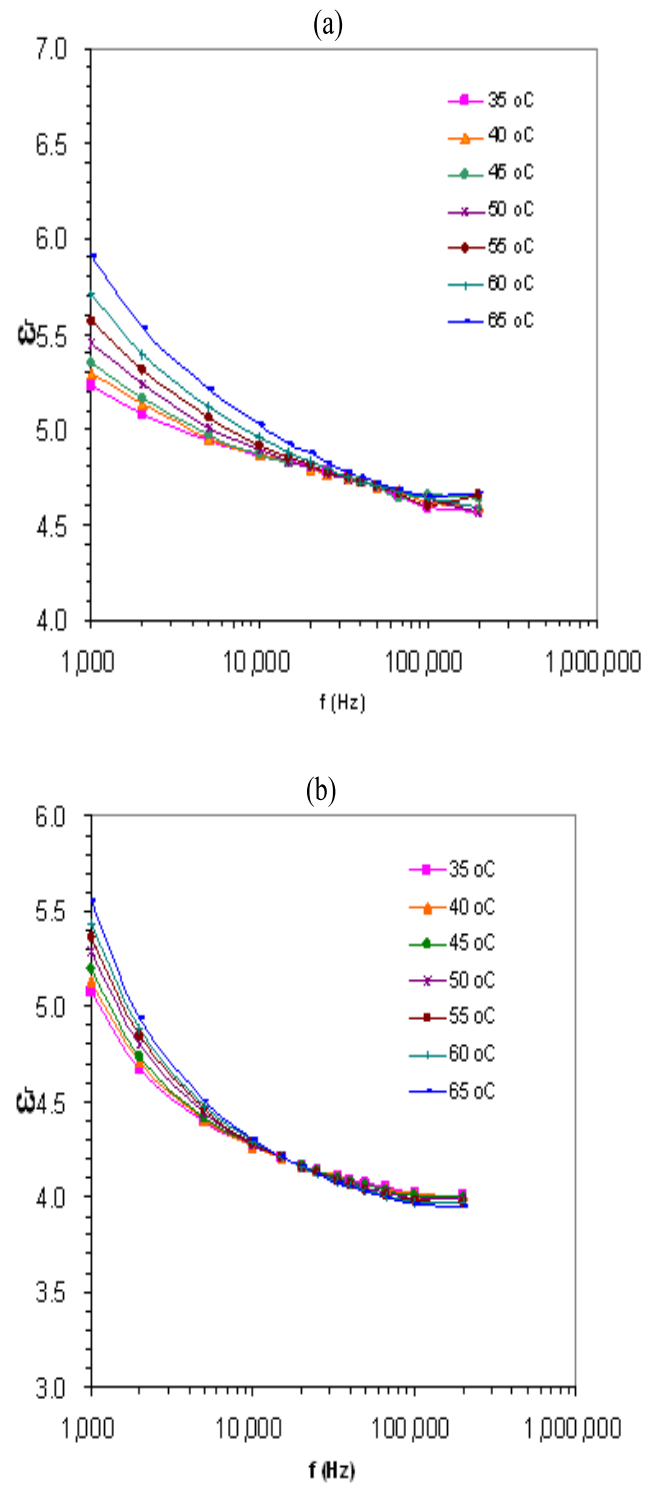
frequencies.

The plot in Figure 6.7 shows the loss factor of the doped KDP crystal grown by conventional and SR methods at different frequencies. Low dielectric loss at high frequencies indicates that the specimen crystal contains very low density of defects. The loss factor of the doped KDP crystal grown by the SR method is lower than the loss factor of the doped KDP crystal grown by the conventional method. The good dielectric properties indicate that the KDP crystal grown by the SR method may be useful for variety of NLO applications.

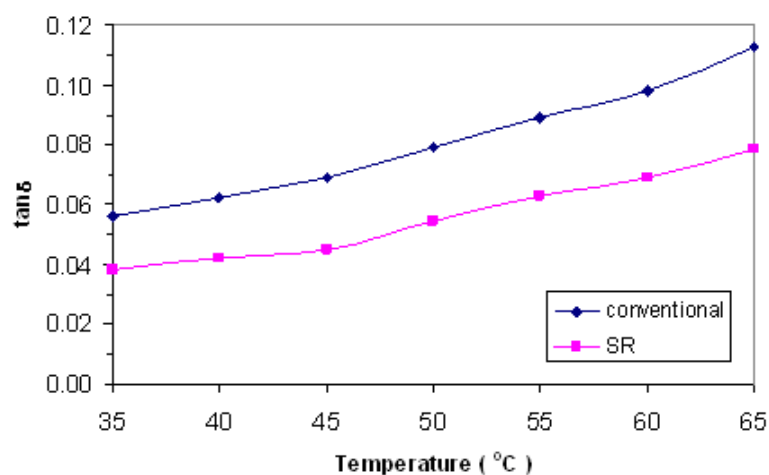
#### 6.4.5 Microhardness testing

Hardness of a material is the resistance it offers to indentation by a much harder body. It may be termed as a measure of the resistance against lattice destruction or the resistance offered to permanent deformation or damage. The hardness properties are basically related to the crystal structure of the material. Microhardness study on the crystals brings out an understanding of the plasticity of the crystal. The most common and reliable method is the Vickers hardness test method. In this method, microindentation is made on the surface of a specimen with the help of diamond indenter. Microhardness studies are carried out using (001) plane of both the conventional and SR method grown crystals (Anton-Paar, MHT-10 Microhardness Tester). Load of different magnitudes was applied. The indentation time was fixed as 10 s for each trial. The Vickers microhardness number was calculated using relation :  $H_v = 1.8544P/d^2$  (kg/mm<sup>2</sup>) where  $P$  is the indenter load (kg) and  $d$  is the diagonal length of the impression (mm). The plot of Vickers hardness versus load for the conventional and SR methods grown L-arginine doped KDP crystals is shown in Figure 6.8. From the graph, it is seen that the hardness value for the SR grown crystal is higher than the hardness of



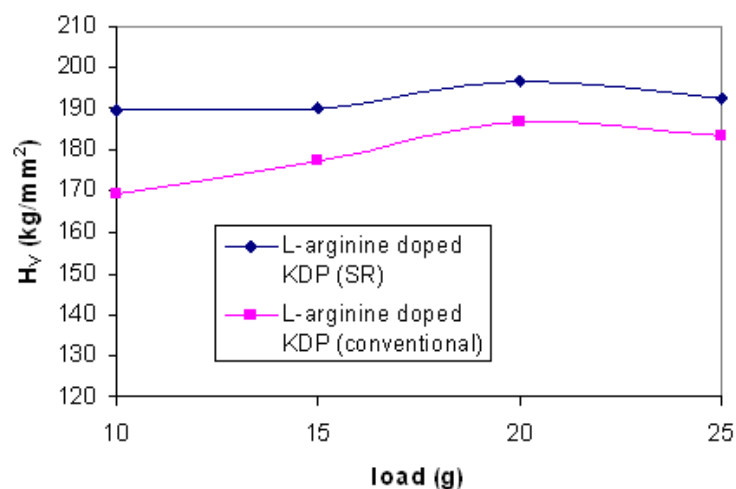


**Figure 6.6** Frequency dependence of dielectric constant at different temperatures of the 1 mole % (a) and 3 mole % (b) L-arginine doped KDP crystals grown by the SR method.



**Figure 6.7** Temperature dependence of dielectric loss at 10 kHz of the 1 mole % L-arginine doped KDP crystals.

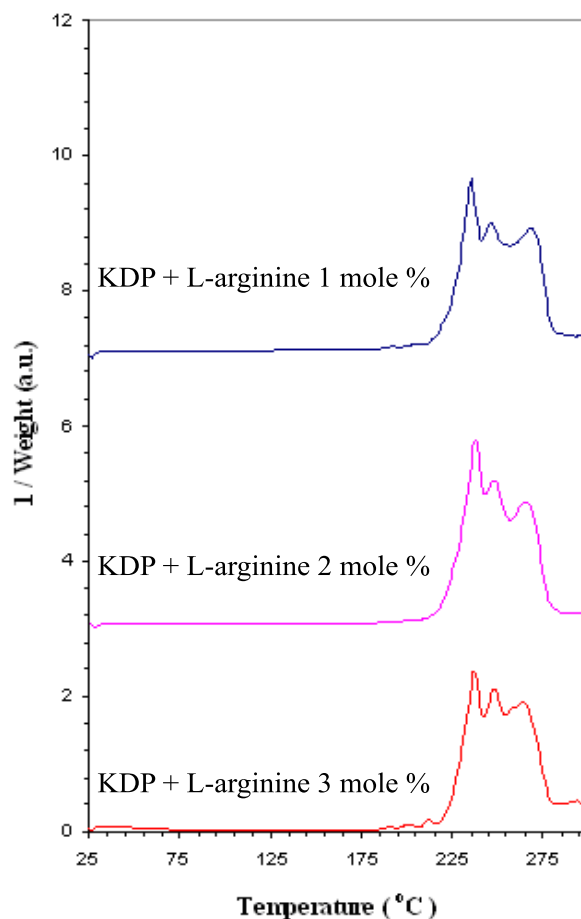
the conventional method grown crystal. Larger hardness value for the SR method grown crystal indicates greater stress required to form dislocation thus confirming greater crystalline perfection. Similar results were reported in several crystals (Rajesh and Ramasamy, 2009; Balamurugan and Ramasamy, 2008; Senthil et al., 2008).



**Figure 6.8** Vickers microhardness of the 1 mole % L-arginine doped KDP crystals.

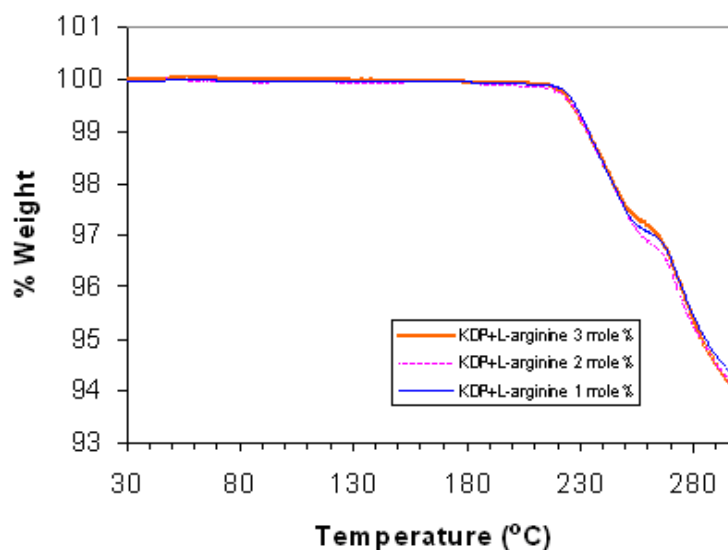
### 6.4.6 Thermal studies

Thermal analysis includes a group of techniques in which the physical property of the substance is measured as a function of temperature while the substance is subjected to a controlled temperature program. When a sample is heated at a controlled rate, the weight of a substance in an environment is recorded and the change of weight is measured as a function of temperature.



**Figure 6.9** Differential Scanning Calorimetry (DSC) data of the pure and L-arginine doped KDP crystals grown by SR method.

In the present study, thermal analysis was carried out on the crushed specimen of the SR method grown crystals by employing a Differential Scanning



**Figure 6.10** 10 Thermogravimetric Analysis data of the L-arginine doped KDP single crystals grown by the SR method.

Calorimeter (Mettler Toledo DSC822) and Thermogravimetric Analyzer (Mettler Toledo TGA/SDTA 851) at 15°C/min heating rate in the nitrogen atmosphere. Figure 6.9 shows the DSC spectra for the L-arginine doped KDP crystals grown by the SR method. It is found that there are endothermic peaks at 236°C, 248°C and 264°C for the 1 mole % of L-arginine, 236°C, 248°C and 266°C for the 2 mole % of L-arginine and 234°C, 246°C and 268°C for the 3 mole % of L-arginine doped KDP crystals. Figure 6.10 illustrates the TG curves for the doped KDP crystals grown by the SR method. The TG curves of the samples indicate that they are stable up to 200°C at least for all samples.

## 6.5 Conclusion

Amino acid L-arginine doped KDP single crystals have been grown by both the conventional and SR methods. The crystal structure and functional groups were confirmed by powder X-ray diffraction and FTIR studies. The optical trans-

mission analysis revealed that the L-arginine doped KDP crystals have very high percentage of transmission in the entire visible region which is very essential for NLO applications. Thermal studies by DSC/TG investigations show that the grown crystals by the SR method are stable up to 200°C. Microhardness measurements also indicate that the crystals grown by the SR method have good crystalline perfection and low density of defects. The good dielectric properties indicated that the L-arginine doped KDP crystal grown by the SR method may be useful for variety of NLO applications.

## 6.6 References

- Babu, R.R., Sethuraman, K., Gopalakrishnan, R. and Ramasamy, P. (2006). Growth of L-lysine monohydrochloride dihydrate bulk single crystal by Sankaranarayanan-Ramasamy (SR) method. **Journal of Crystal Growth.** 297(2): 356.
- Balamurugan, S. and Ramasamy, P. (2008). Bulk growth of 1 0 1 KDP crystal by Sankaranarayanan-Ramasamy method and its characterization. **Materials Chemistry and Physics.** 112(1): 4.
- Claude, A., Vaithianathan, V., Ganesh, R.B., Sathyalakshmi, R and Ramasamy, P. (2006). Crystal growth of novel bimetallic Nickel, Magnesium ( $\text{Ni}^{3+}$ ,  $\text{Mg}^{2+}$ ) Potassium dihydrogen phosphate by solution growth and their characterization. **Journal of Applied Sciences.** 6(3): 635.
- Gunasekaran, S., Ponnusamy, S. and Rajasekaran, R. (2004). Growth and characterisation of potassium dihydrogen phosphate (KDP) crystal doped with ammo acid. **Indian Journal of Physics.** 78(7): 553.

- Kannan, V., Ganesh, R.B., Sathyalakshmi, R, Rajesh, N.P. and Ramasamy, P. (2006). Investigation of  $\text{La}^{3+}$  ions on growth and NLO properties of KDP single crystals. **Crystal Research and Technology**. 41(7): 678.
- Meena, M. and Mahadevan, C.K. (2008). Growth and electrical characterization of L-arginine added KDP and ADP single crystals. **Crystal Research and Technology**. 43(2): 166.
- Parikh, K.D., Dave, D.J., Parekh, B.B. and Joshi, M.J. (2007). Thermal, FT-IR and SHG efficiency studies of L-arginine doped KDP crystals. **Bulletin of Materials Science**. 3(2): 105.
- Podder, J., Ramalingom, S. and Kalkura, S.N. (2001). An investigation on the lattice distortions in urea and KCl doped KDP single crystals by X-ray diffraction studies. **Crystal Research and Technology**. 36(6): 549.
- Rajesh, P. and Ramasamy, P. (2009). Growth of dl-malic acid-doped ammonium dihydrogen phosphate crystal and its characterization. **Journal of Crystal Growth**. 311(13): 3491.
- Sankaranarayanan, K. and Ramasamy, P. (2005). Unidirectional seeded single crystal growth from solution of benzophenone. **Journal of Crystal Growth**. 280(3-4): 467.
- Senthil Pandian, M., Balamurugan, N., Ganesh, V., Rajasekar, N.V., Kishan Rao, K.K. and Ramasamy, P. (2008). Growth of TGS single crystal by conventional and SR method and its analysis on the basis of mechanical, thermal, optical and etching studies. **Materials Letters**. 62(2): 3830.
- Wang, B., Fang, Ch., Wang, Sh., Sun, X., Li, Q.G.Y., Xu, X., Zhang, J., Liu, B. and Mou, X. (2006). The effect of  $\text{Sn}^{4+}$  ion on the growth habit and

optical properties of KDP crystal. **Journal of Crystal Growth.** 297(2):  
352.

# CHAPTER VII

## CONCLUSIONS

### 7.1 Growth and characterization of the pure and $K^+$ doped zinc thiourea chloride crystals

Pure and  $K^+$  doped single crystals of Zinc Thiourea Chloride were grown by slow solvent evaporation technique and large size single crystals of pure ZTC were grown by the SR method. Powder XRD and FTIR studies of both the pure and doped samples were carried out and the results were compared. Powder X-ray diffraction studies of the pure ZTC crystals grown by both the conventional and SR methods confirmed the orthorhombic structure of the grown crystals. In addition, powder x-ray diffraction studies of the ZTC crystals doped with 0.2, 1.0 and 2.0 mole % of  $K^+$  grown by conventional method also confirmed the orthorhombic structure of the grown crystals. The crystal structure and functional groups were confirmed. Dielectric constants of both the pure and doped samples were measured. Good dielectric properties were observed in the present investigations. The optical absorption analysis revealed that the pure and 0.2 mole % of  $K^+$  doped ZTC crystals have very low percentage of absorption in the entire visible region, which is a very essential property for NLO crystals. Low dielectric loss at high frequencies indicates that the specimen crystal contains very low density of defects. The dielectric loss of the pure ZTC crystal grown by the SR method is lower than the pure ZTC crystal grown by the conventional method. Dielectric measurement indicates that the crystal grown by the SR method has good crystalline perfection



and low density of defects. The good dielectric properties show that the ZTC crystal grown by the SR method may be useful for variety of NLO applications.

## **7.2 Growth and characterization of the pure, L-arginine and glycine doped ADP single crystals**

Pure, amino acid L-arginine and glycine doped ADP single crystals were grown by the slow solvent evaporation method and large size single crystals of the pure and doped ADP were grown by the SR method. Powder XRD studies of the samples were carried out and FTIR studies were performed to identify the presence of various functional groups in the grown crystals. The crystal structure and functional groups were confirmed. Dielectric properties of both the pure and doped samples were measured. The dielectric loss of the doped ADP crystals grown by the SR method is lower than the dielectric loss of the doped ADP crystals grown by the conventional method. The good dielectric properties indicated that the doped ADP crystal grown by the SR method may be useful for variety of NLO applications. The optical absorption analysis revealed that the pure and doped ADP crystals have very low percentage of absorption in the entire visible region, which is very essential for NLO crystals. The DSC and TG curves of the grown crystals indicated that they were stable up to 200°C and larger hardness value for the SR method grown crystal confirmed greater crystalline perfection. The hardness value for the SR grown crystals is higher than the hardness of the conventional method grown crystals. Larger hardness value for the SR method grown crystals indicates a greater stress required to form dislocation; thus confirming greater crystalline perfection. Dielectric and microhardness measurements also indicate that the crystals grown by the SR method have good crystalline perfection and low density of defects.

### **7.3 Growth of the amino acid glycine doped KDP single crystals and their characterization**

Amino acid glycine doped potassium dihydrogen phosphate crystals were grown by the SR method. Powder XRD and FTIR of the samples were carried out. The crystals were identified by comparing the interplanar spacing and intensities of the XRD pattern with the JCPDS data of KDP crystals. The slight shift in the  $2\theta$  values of the doped crystals suggests that their structure was slightly disturbed compared to the pure KDP crystals. The crystal structure and functional groups were confirmed. The optical transmission analysis indicates that the pure and doped KDP crystals have high percentage of transmission in the entire visible region. The DSC and TG investigations show that the grown crystals are stable up to 200°C. Dielectric constants and dielectric loss of the samples grown by the conventional and SR methods were measured. Their good dielectric properties show that the glycine doped KDP crystal grown by the SR method may be useful for various applications. The optical transmission analysis revealed that the glycine doped KDP crystals have very high percentage of transmission in the entire visible region, coupled with good dielectric properties, which is very essential for NLO crystals. The hardness value for the SR grown crystal is higher than the hardness of the conventional method grown crystal. Vickers microhardness study shows higher mechanical stability in doped KDP crystals grown by the SR method. Dielectric and microhardness measurements also indicate that the crystals grown by the SR method have good crystalline perfection and low density of defects.

## 7.4 Growth of the amino acid L-arginine doped KDP single crystals and their characterization

Single crystals of the amino acid L-arginine doped Potassium dihydrogen phosphate were grown by both the conventional and SR methods. Powder XRD, FTIR, microhardness, thermal and dielectric properties studies of the samples were carried out. Powder X-ray diffraction studies of the doped KDP crystals grown by both the conventional and SR methods confirmed the tetragonal structure of the grown crystals. Results were compared with the JCPDS database where the prominent peaks of the reported values coincided with the investigated patterns. In the spectra of amino acid L-arginine doped crystals, some bands of  $\text{H}_2\text{PO}_4^-$  overlap with amino acid vibrations. The crystal structure and functional groups were confirmed by powder X-ray diffraction and FTIR studies. The optical transmission analysis indicates that the pure and amino acid glycine doped KDP crystals have high percentage of transmission in the entire visible region which is very essential for NLO applications. Thermal studies by DSC/TG investigations show that the grown crystals by the SR method are stable up to 200°C. The hardness value for the SR grown crystal is higher than the hardness of the conventional method grown crystal. Microhardness measurements also indicate that the crystals grown by the SR method have good crystalline perfection and low density of defects. The loss factor of the doped KDP crystal grown by the SR method is lower than the loss factor of the doped KDP crystal grown by conventional method. Their good dielectric and good mechanical properties show that the L-arginine doped KDP crystals grown by the SR method may be useful for various applications.

In conclusion, NLO crystals continue to be interesting materials both academically and industrially. Uniaxial solution crystallization method of

Sankaranarayanan-Ramasamy (SR method) is a novel method to grow single crystals with many advantages. The main advantages of the SR solution growth method are simple experimental set-up, unidirectional growth, high solute-solid conversion, minimum thermal stress on the crystal during growth and prevention of microbial growth. Growth by the SR method of NLO single crystals such as metal complexes of thiourea, KDP and ADP doped with other amino acids are still very interesting for future investigation.

## CURRICULUM VITAE

The author, Mr. Nakarin Pattanaboonmee, was born on the 5<sup>th</sup> February 1980 in Meaung District of Nakhonnayok Province, Thailand. In March, 2002, he obtained his Bachelor degree in Physics with 1<sup>st</sup> Class Honner from the Department of Physics, Faculty of Science at King Mongkut's University of Technology Thonburi. In May, 2002, he started his post graduate study at the same department and graduated in 2005. His M.Sc. thesis involved a study on Frustrated Total internal reflection and applications. In December 2005, he continued his education, by pursuing his Doctoral's degree at the School of Physics, Institute of Science, Suranaree University of technology. His Ph.D. thesis was entitled "Growth and Characterization of Pure and Doped Single Crystals of Zinc Thiourea Chloride, Potassium Dihydrogen Phosphate and Ammonium Dihydrogen Phosphate" which was under the supervision of Assoc.Prof. Dr. Prapun Manyum. His Ph.D. study was supported by King Mongkut's University of Technology Thonburi. Nakarin successfully obtained his Ph.D. degree in 2010. He now works as a Lecturer of Physics at King Mongkut's University of Technology Thonburi. His research interest is on crystal growth and characterization.