

Probabilistic neural network classification for Model β -Glucan Suspensions

RATCHADAPORN OONSIVILAI¹ and ANANT OONSIVILAI²

School of Food Technology¹

School of Electrical Engineering²

Suranaree University of Technology

111 University Avenue, Muang, Nakhon Ratchasima, 30000

THAILAND

roonsivi@sut.ac.th¹, *anant@sut.ac.th² <http://www.sut.ac.th>

Abstract: The problems encountered in brewing commonly attributed to excess β -glucan levels include low extract yield, increased lauter runoff times, formation of gelatinous precipitates during aging, and decreased filtration efficiency. Several rheological techniques were used to determine C^* or critical concentration where β -glucan aggregates begin to entangle and there was a relationship between intrinsic viscosity and C^* . This study reports applying Probabilistic Neural Network (PNN) to get new data set of relation between reciprocal of logarithm of relative viscosity $1/\log(\eta_{rel})$ and β -glucan concentration in seven model buffer systems and thus could be used for C^* value determination with better statistical correlation.

Key-Words: β -Glucan, PNN, Critical concentration, Relative Viscosity, Neural Network

1 Introduction

1.1 β -Glucan

β -Glucan are complex carbohydrates composed of mixed linkage (1 \rightarrow 3), (1 \rightarrow 4) β -D-glucose polymers. They comprise an important component found in the cell walls of barley and oats and to a lesser extent in other cereal grains. They are nonstarchy polysaccharides found in the aleurone cell layer and in the cell walls of the endosperm [1].

1.2 Beer Filtration and Beta-Glucan Gel Formation

Beta-glucan polymers present in beer can increase beer consistency and impair filtration. Membrane filtration depends upon retention of solids at the surface of the filter. Plaques are believed to develop on membrane surfaces during clogging. The membrane initially behaves like a cake filter, and the flow rate is reduced proportional to the volume that has passed through the filter. Mechanism has an exponential dependency, meaning that blocking of the membrane pores quickly becomes the dominant mechanism [2]. A mechanism of β -glucan gel formation where the worm-like conformation of the polymer linked by β -1,3-sections (at irregular intervals) hinder extensive intermolecular association was proposed [3]. The intermolecular junction zones are indicated by the aggregation of

double helices in Fig. 1, each straight line representing blocks of β -1,4-linkages [3].

1.3 Determination of Intrinsic Viscosity and Critical Concentration

When a polymer is dissolved in a solvent, there is a noticeable increase in the viscosity of the resulting

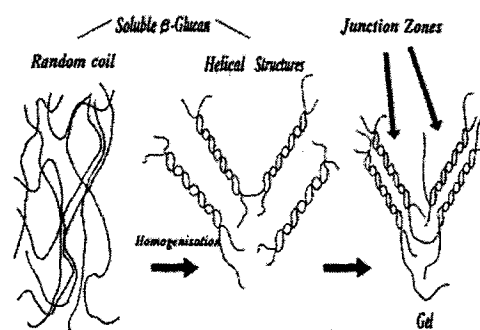

Fig. 1 Schematic representation of a proposed mechanism for gel formation by beer β -glucans [3].

solution. The viscosity of pure solvents and solutions can be measured and various values calculated from the resulting data [4]. The intrinsic viscosity, $[\eta]$, can be defined as the limit of the reduced viscosity (η_{red}); the ratio of specific viscosity

to concentration) or the inherent viscosity (η_{inh} ; the ratio of log relative viscosity to concentration) as the polymer concentration approaches zero:

$$[\eta] = \lim_{c \rightarrow 0} \left[\frac{\eta - \eta_s}{\eta_s c} \right] = \lim_{c \rightarrow 0} \frac{\eta_{sp}}{c} \quad (1)$$

where η_s is viscosity of the solvent, η_{sp} is specific viscosity, and C is concentration [5].

The concentration dependence of a solution viscosity of polymers can be described by Martin equation up to moderate concentrations, and this equation constant provides a measure of polymer-polymer interactions in a given solvent. The Martin equation can be applied to determine intrinsic viscosity and can be described as follows:

$$\eta_{sp}/C[\eta] = \exp(K_m C [\eta]) \quad (2)$$

where K_m is a constant.

As the concentration of polymer increases, overlapping of macromolecular chains becomes important and the relative viscosity of solution increases significantly with an increase in concentration, up to a critical concentration. This region, called the semidilute regime, is found in the $C[\eta]$ range of 1.0 to 10.0. Above the critical concentration (C^*), the entanglements between polymers increase sharply and so does the viscosity of solution with concentration, and it occurs when $C[\eta] > 10.0$. The Martin equation best described the viscosity-concentration relationship of a number of dilute and moderately concentrated polymer solutions. Furthermore, the critical concentration (C^*) is reported to be equal to C when $C[\eta] = 1.0$ [6]. Lineman and Kruger [7] had determined critical concentration based on the representation of the reciprocal logarithm of the relative viscosity $1/\log(\eta_{rel})$ as a function of the concentration where the relative viscosity is defined as $\eta_{rel} = \eta/\eta_0$. The entanglement or overlap concentration C^* is defined as the inflection point in a plot of concentration as a function of $1/\log(\eta_{rel})$ as shown in Fig. 2.

Like most polymers, the effect of β -glucan levels on apparent viscosity is linear only at low concentrations. With increasing concentration the apparent viscosity rises exponentially. The critical concentration is defined as the concentration that corresponds to the transformation from a dilute to a

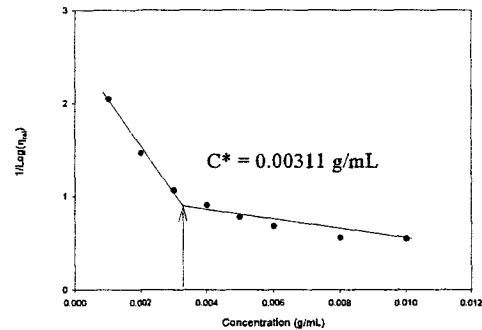

Fig. 2 Determination of overlap concentration C^* from a plot of concentration as a function of $1/\log(\eta_{rel})$.

semi-dilute solution in which the dissolved molecule coils start to overlap each other [8]. Fig. 2 depicts the determination of overlap concentration C^* from a plot of concentration as a function of $1/\log(\eta_{rel})$.

2 Probabilistic Neural Network Classifier

Probabilistic neural networks can be used for classification problems. When an input is presented, the first layer computes distances from the input vector to the training input vectors, and produces a vector whose elements indicate how close the input is to a training input. The second layer sums these contributions for each class of inputs to produce as its net output a vector of probabilities. Finally, a *compete* transfer function on the output of the second layer picks the maximum of these probabilities, and produces a 1 for that class and a 0 for the other classes. The architecture for this system is shown below.

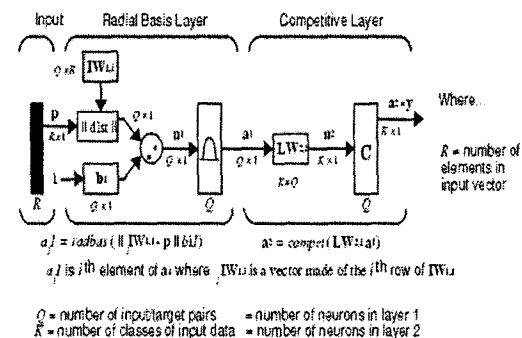

Fig. 3 The architecture of a Probabilistic Neural Network [9].

it is assumed that there are Q input vector/target vector pairs. Each target vector has K elements. One of these element is 1 and the rest is 0. Thus, each input vector is associated with one of K classes.

The first-layer input weights, $IW^{1,1}$ (net.IW{1,1}) are set to the transpose of the matrix formed from the Q training pairs, P^t . When an input is presented the $\|dist\|$ box produces a vector whose elements indicate how close the input is to the vectors of the training set. These elements are multiplied, element by element, by the bias and sent the radbas transfer function. An input vector close to a training vector is represented by a number close to 1 in the output vector a^1 . If an input is close to several training vectors of a single class, it is represented by several elements of a^1 that are close to 1.

The second-layer weights, $LW^{1,2}$ (net.LW{2,1}), are set to the matrix T of target vectors. Each vector has a 1 only in the row associated with that particular class of input, and 0's elsewhere. (A function `ind2vec` is used to create the proper vectors.) The multiplication Ta^1 sums the elements of a^1 due to each of the K input classes. Finally, the second-layer transfer function, `compete`, produces a 1 corresponding to the largest element of n^2 , and 0's elsewhere. Thus, the network has classified the input vector into a specific one of K classes because that class had the maximum probability of being correct [9]

Neural networks can provide several advantages over conventional regression models. They are claimed to possess the property to learn from a set of data without the need for a full specification of the decision model; they are believed to automatically provide any needed data transformations [10]. Neural net work was applied for rapid assessment of microbiological quality of bulk raw milk [11] A novel probability neural network (PNN) could classify data for both continuous and categoric input data types. A mixture model of continuous and categorical variables was proposed to construct a probability density function (PDF) that is the key part for the PNN [12]. Probabilistic Neural Networks (PNN) had been proposed to explore classifying microarray data patterns in gene expressions. The approach employs representative data that has patterns already identified to conduct training and testing of the classification capabilities of the PNN. A high level classification rate could be achieved with the model with low time and model complexity [13].

The performance of power system dynamic load modeling using adaptive-network-base fuzzy

inference system (ANFIS) was compared with traditional architectures. The ANFIS models could represent nonlinear systems performance accurately, and they were promising for dynamic load models. Computer simulations show excellent results using this approach for power system dynamics [14]

An approach for predicting electric power system commercial load using a wavelet neural network. Morlet and Mexican hat wavelets were used to generate the transfer functions of hidden layer nodes of the neural network. A wavelet neural network was trained for a particular power system load. Results showed that wavelet neural networks may outperform traditional architectures in approximation and forecasting problems related to electric power system [15].

3 Data Acquisition and Preprocessing

The relation between reciprocal logarithm of relative viscosity ($1/\log(\eta_{rel})$) and β -glucan concentration data was obtained from an experiment described in Oonsivilai et al. [1],[4]. This experiment used seven buffer system model to study effect of pH, maltose, and ethanol in buffer on rheological properties of β -glucan suspensions. In addition, from a plot of relation of reciprocal logarithm of relative viscosity ($1/\log(\eta_{rel})$) and β -glucan concentration, critical concentration (C^*) could be determined by piecewise regression by Systat (SPSS Inc, IL). The difficulty of C^* determination by this method is how to get good correlation (r^2) by piecewise regression due to small amount of data points. In experiment, it is complex to vary β -glucan concentration in very small increment due to its polymer like suspension characteristics and also cost benefit.

The PNN became interested and useful in way of application for determination of the C^* value by getting more data points and pieewise non linear regression method could be applied and get more accurate C^* value and better statistical correlation results as shown in Table1.

The comparison between experiment data set and PNN data set are shown in Fig.4 to Fig10.

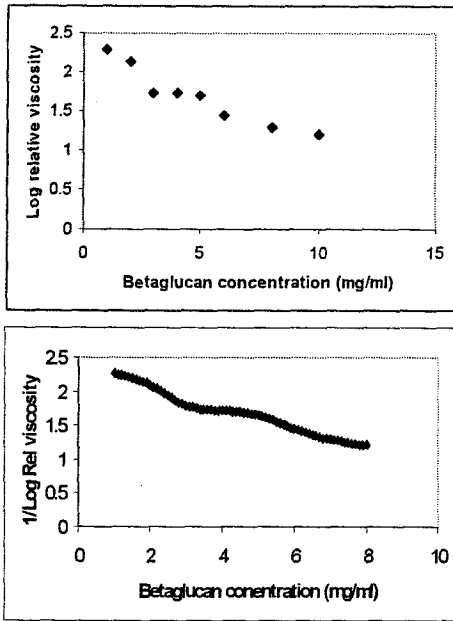

Fig 4. Comparison between two data set (A and B); A: Experimental data of β -glucan in high ethanol buffer system, B: PNN data of β -glucan in high ethanol buffer system.

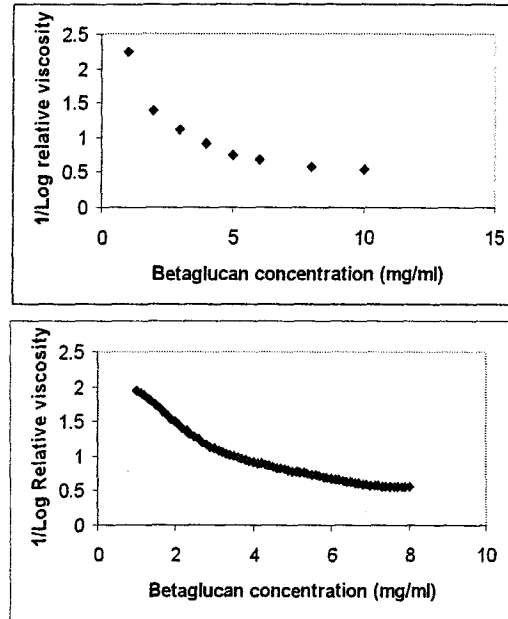

Fig 6. Comparison between two data set (A and B); A: Experimental data of β -glucan in high ethanol buffer system, B: PNN data of β -glucan in control buffer system.

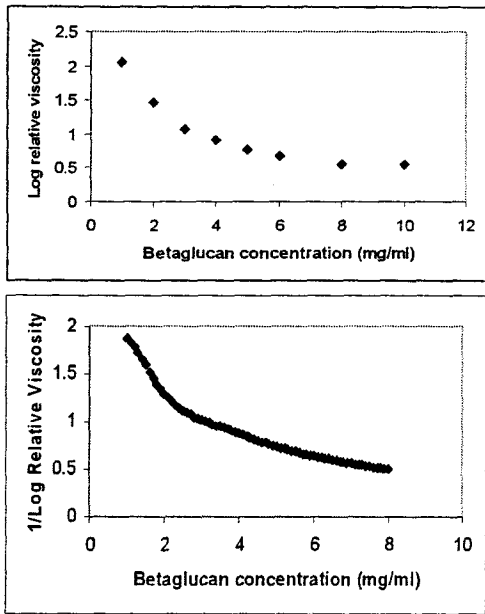

Fig 5. Comparison between two data sets (A and B); A: Experimental data of β -glucan in high ethanol buffer system, B: PNN data of β -glucan in low ethanol buffer system.

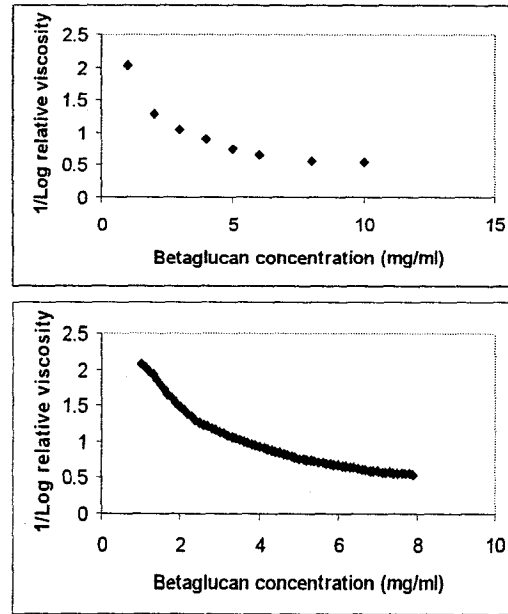

Fig 7. Comparison between two data set (A and B); A: Experimental data of β -glucan in high ethanol buffer system, B: PNN data of β -glucan in high maltose buffer system.

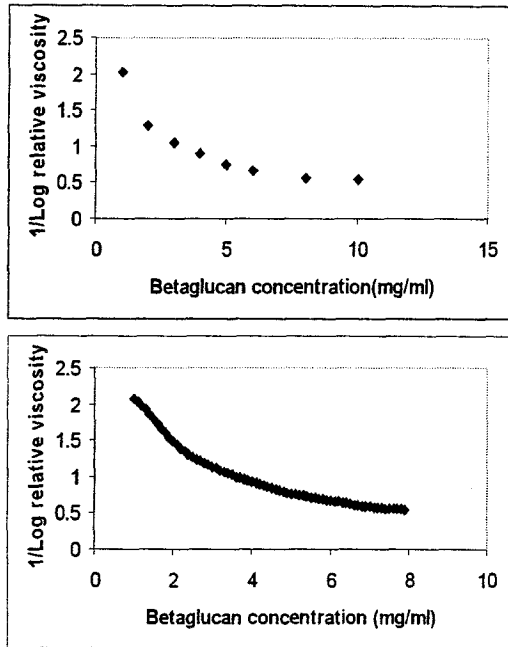

Fig 8. Comparison between two data set (A and B); A: Experimental data of β -glucan in high ethanol buffer system, B: PNN data of β -glucan in low maltose buffer system.

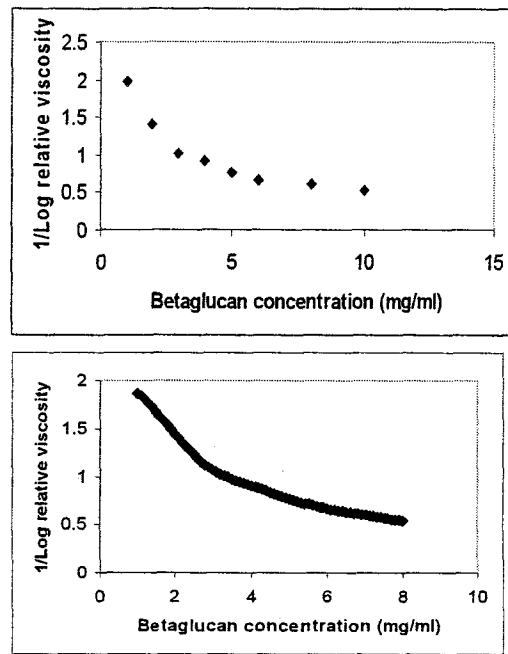

Figure 10. Comparison between two data set (A and B); A: Experimental data of β -glucan in high ethanol buffer system, B: PNN data of β -glucan in high pH buffer system.

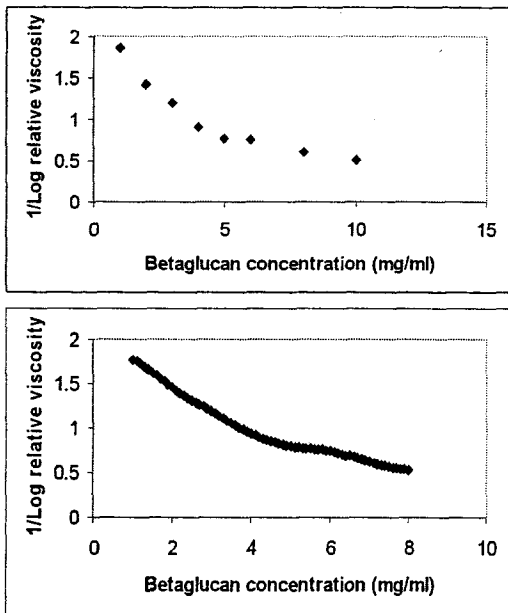

Fig 9. Comparison between two data set (A and B); A: Experimental data of β -glucan in high ethanol buffer system, B: PNN data of β -glucan in low pH buffer system.

Table 1. Comparison of the critical concentration value from experiments and from PNN model.

Buffer condition	C*(old) mg/ml	C*(new) mg/ml	r ² (old)	r ² (new)
High ethanol	0.65	0.64	0.967	0.967
Low ethanol	0.27	0.26	0.942	0.975
Control	0.32	0.32	0.912	0.956
High maltose	0.21	0.25	0.924	0.969
Low maltose	0.31	0.31	0.911	0.959
Low pH	0.39	0.4	0.965	0.983
High pH	0.31	0.32	0.904	0.968

Practically, in laboratory when we need to determine the critical concentration value (C^*), it was time consumed and quite complex to vary concentration in very small increment. The reason due to the natural polymer like solution behavior of β -glucan solutions especially when the environments such as pH, temperature, ethanol concentration, and maltose concentration in suspensions change, the rheological properties of solutions would change noticeably. Thus applying PNN model by using Parzen Probabilistic density functions (pdf) estimators which asymptotically approach the underlying parent density provided that it is smooth and continuous to get new data set that composed of more data points and then use this data set for determination of the C^* value would be really helpful and more adequate.

4 Conclusion

Applying the PNN model to get new β -Glucan data set for determination of C^* value gave the new C^* value which showed better statistical correlation from piecewise non linear regression. Moreover, this method could be used in C^* value determination in other polymer behavior like solutions. Especially in brewing process that the C^* value of β -glucan is very important for monitoring in process of beer filter. Finally, PNN is model that very useful in data analysis especially in physical properties analysis of food or concentrated polymer like solutions in very condition such as pH and temperature.

References:

- [1] Oonsivilai, R. The effect of β -glucan polymers on the rheological and filtration properties of wort. *MSc. Thesis*. Dalhousie University-Daltech, Halifax, NS. Canada. 2000.
- [2] Flores, T, Role of wort beta-glucan in lautering. *M. Sc. Thesis, University of California, Davis, CA, 1997.*
- [3] Letters, R., Byrne, H and Doherty, M, The complexity of beer, *EBC Congress. Helsinki, Finland. 1985*, pp. 395-402.
- [4] Oonsivilai, R. Patelakis, S.J.J., Speers, R.A., and Paulson, A.T, Rheological and filtration properties of beta-glucan polymers in the brewing process. *CIFST Annual Meeting, Presentation #OR-12, June 6-9, Kelowna, BC, 1999.*
- [5] Kozicki, W. and Kuang, P.Q, Alternative method for evaluation of intrinsic viscosity, *Canadian Journal of Chemistry Engineering*, Vol. 74, 1996, pp 429-432.
- [6] Kasaai, M.R., Charlet, G., and Arul, J, Master curve for concentration dependence of semi-dilute solution viscosity of chitosan homologues: the Martin equation, *Food Research International*. Vol. 33, 2000, pp 63-67.
- [7] Linemann, A. and Kruger, E, Relationships between structure and characteristics of β -glucan in beer production. part II: Changes in state of dissolution of β -glucan and formation of β -glucan gel during the brewing process. *Brauwelt International*, Vol. 16 1998, pp132-139.
- [8] Linemann, A. and Kruger, E, Relationships between structure and characteristics of β -glucan in beer production, part I: Properties in dissolving β -glucan out of beer, *Brauwelt International*. Vol. 15, No. 4, 1997, pp 344-351.
- [9] Alexandra, I. and H. Morton, *An introduction to Neural Computing*. Chapman and Hall, London, 1990.
- [10] Marquez, L., Hill, T., Worthly, R., and Remus, W, Neural network model as alternative to regression, *IEEE*, Vol. 91, 1991, pp 129-135.
- [11] Jindal, V.K. and Homhual, S, Applying neural networks for rapid assessment of microbiological quality of bulk raw milk. *Engineering Journal Kasetsart*. Vol. 14 No 41, 2000, pp. 69-86.
- [12] Cang, S. and Yu, H, Novel probability neural network, *IEEE Proc-Vis Image Signal Process*, Vol. 152, No. 5, 2005, pp 535-544.
- [13] Comes, B. and Keleman, A, Probabilistic neural network classification for microarraydata, *IEEE Proceeding of the international*, 2003, pp 1714-1717.
- [14] Oonsivilai, A. and El-Hawary, M.E, Power system dynamic load modeling using adaptive-network-based fuzzy inference system, *IEEE Canadian Conference on Electrical and Computer Engineering*, Vol. 3, 1999, pp 1217 - 1222.
- [15] Oonsivilai, A. and El-Hawary, M.E, Wavelet neural network based short term load forecasting of electric power system commercial load, *IEEE Canadian Conference on Electrical and Computer Engineering*, Vol. 3, 1999, pp 1223-1228.